

PANORAMA

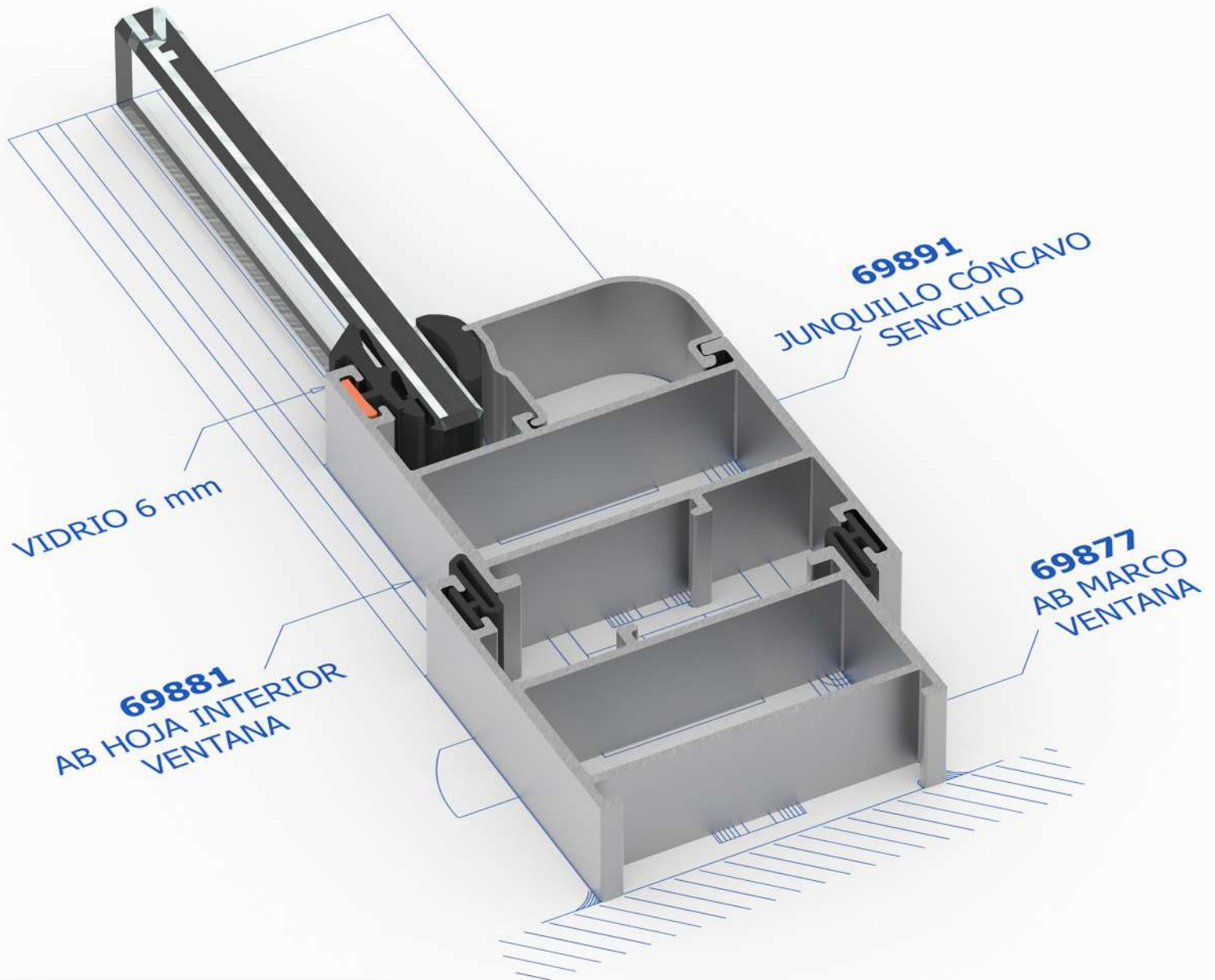

CATÁLOGO
SÓLO PERFILES
PANORAMA
2022

PANORAMA

Código Cuprum: CPSP-2022
Edición: Primer semestre 2022

PANORAMA

Somos una empresa 100% mexicana, líder en la industria del aluminio con 70 años en el mercado. Nuestros procesos están alineados de manera vertical desde la fundición, extrusión y acabados, realizados con los más estrictos estándares de calidad.

Nuestros diseños innovadores, atención y servicio nos ha convertido como la mejor opción en el mercado de la construcción.

Presentamos la nueva edición del catálogo **Panorama 2022**, línea exclusiva de Cuprum dirigida a la vivienda de interés social y media, cumpliendo con las necesidades básicas para la construcción arquitectónica. Podrás encontrar desde acabados y perfiles para el armado de sistemas: fijos, corredizos y batientes, además de cancel de baño, pasamanos, fachadas arquitectónicas, entre otros.

El propósito de Cuprum es continuar desarrollando a los Profesionales del Aluminio para cumplir con las expectativas de nuestros clientes.

Alumineros hay muchos... Profesionales del Aluminio solo en Cuprum.



www.cuprum.com

Índice

Fijos

Fijo de 1.500" x 1.084"	4
Fijo Serie AB	5
Fijo de 2.000" x 1.250"	6
Fijo de 3.000" x 1.750"	7
Fijo de 3.000" x 1.250"	9
Fijo de 3.000" x 1.250" Doble Vidrio	10
Fijo de 4.000" x 1.750"	11

Corredizas

Ventana Económica de 1.500" C-Light	13
Ventana y Puerta Corrediza 2.000" x 1.250"	14
Ventana y Puerta Corrediza 3.000" x 1.250"	16
Mosquiteros y Adaptadores	19
Ventana Guillotina California 1.670"	20
Puerta Corrediza California 3.625"	21

Ventanas

Ventana Batiente Serie AB	22
Ventana de Proyección 2.000"	23
Ventana Sifón 3.000"	24

Puertas

Puerta Batiente de 1.000" Económica	25
Puerta Batiente Serie AB	26
Puerta Batiente de 1.750" Comercial	28

Cancel de Baño

Cancel de Baño de Lujo y Semi Lujo	30
Cancel de Baño Ligero	31
Cancel de Baño Varios	32

Aparadores y Vitrinas

32

Recubrimientos

33

Sardinel

35

Zoclo y Repizón

35

Pasamanos

36

Celosías Louver

37

Fachada Arquitectónica

39

Std. Arquitectónico

42

Índice General

44

Pintura electrostática

- 100 - Blanco
- 101 - Hueso
- 108 - Champagne
- 107 - Negro
- 184 - Chocolate
- 737 - Gris Europa

Anodizados

- 005 - Champagne Brillante
- 010 - Natural Brillante
- 011 - Natural Mate
- 040 - Champagne Mate
- 084 - Bronce oscuro

Acabados Madera

- 601 - Madera Cerezo
- 603 - Nogal Texturizado

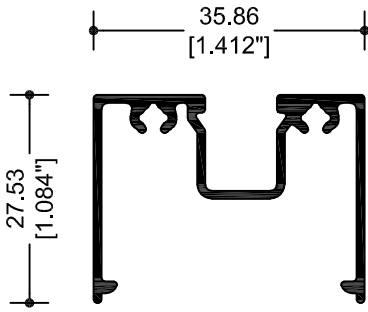

39073
BOLSA

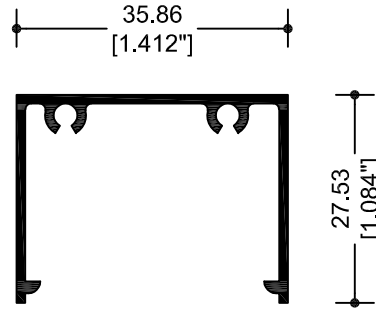

29076
BOLSA LISA

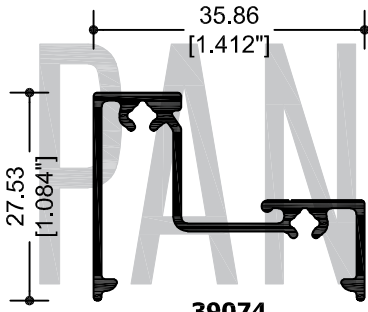

39074
ESCALONADO

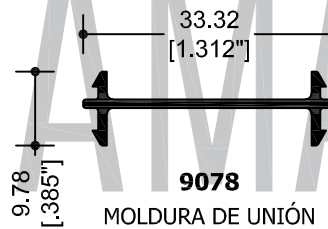
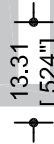

9078
MOLDURA DE UNIÓN
MULLION
PRODUCCIÓN
SIN ACABADO

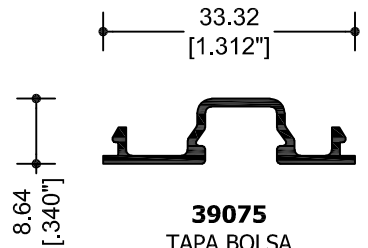

39075
TAPA BOLSA

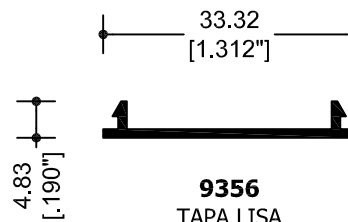

9356
TAPA LISA

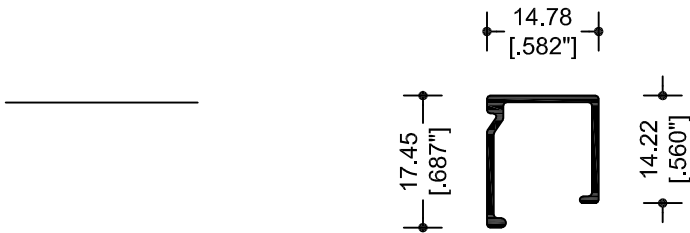

36370
JUNQUILLO

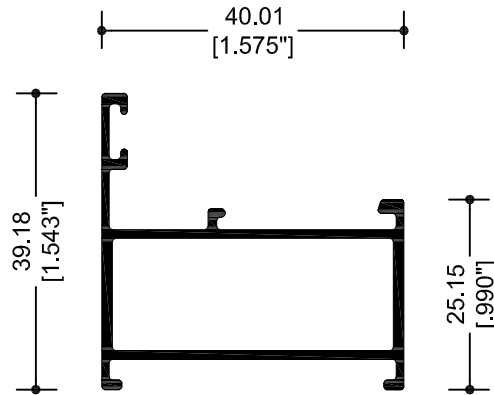

69877
MARCO VENTANA

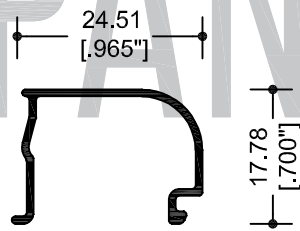

69891
JUNQUILLO CONCAVO
SENCILLO (6mm)

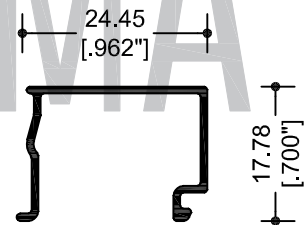

69890
JUNQUILLO CUADRADO
SENCILLO (6mm)

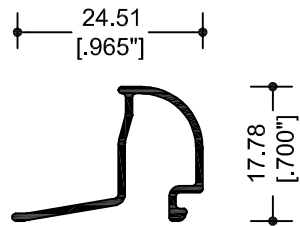

69887
JUNQUILLO CONCAVO
DOBLE (18mm)

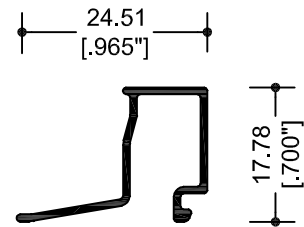

69888
JUNQUILLO CUADRADO
DOBLE (18mm)

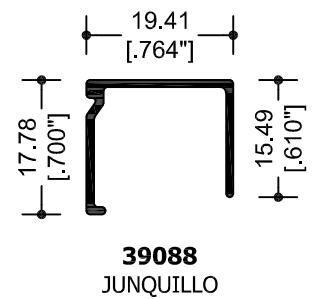
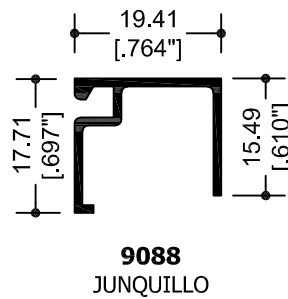
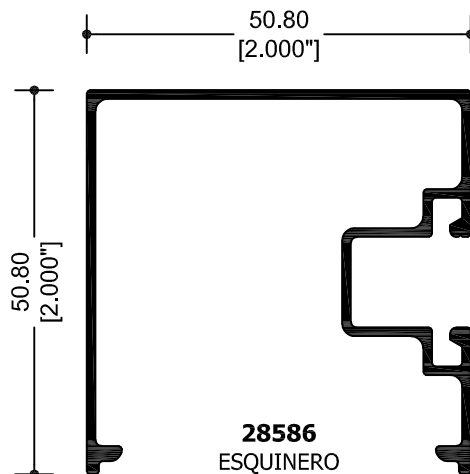
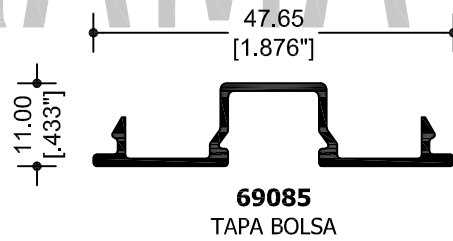
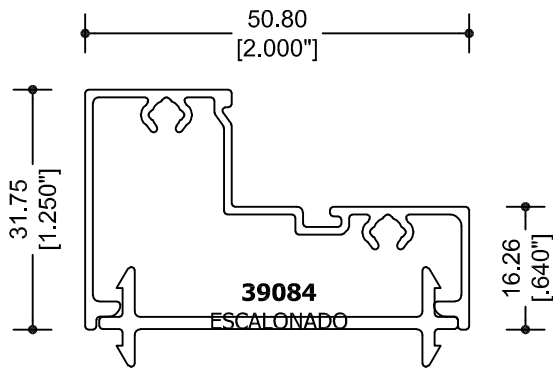
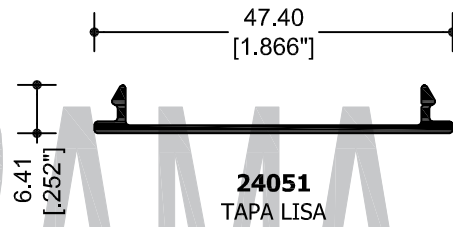
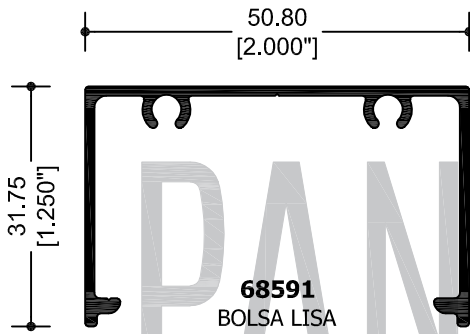
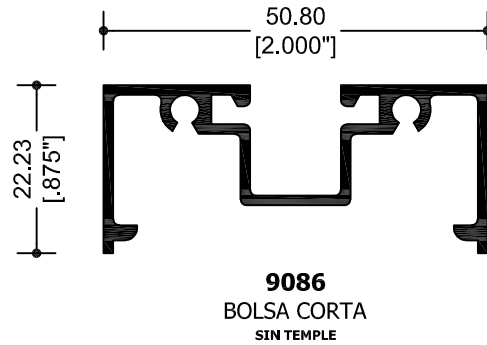
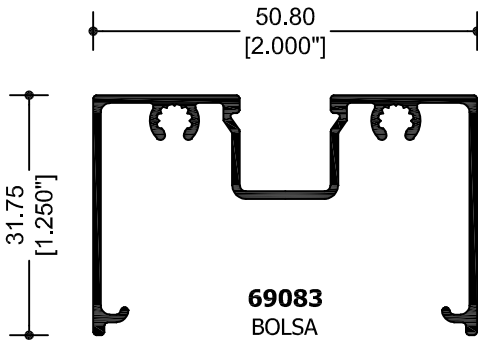

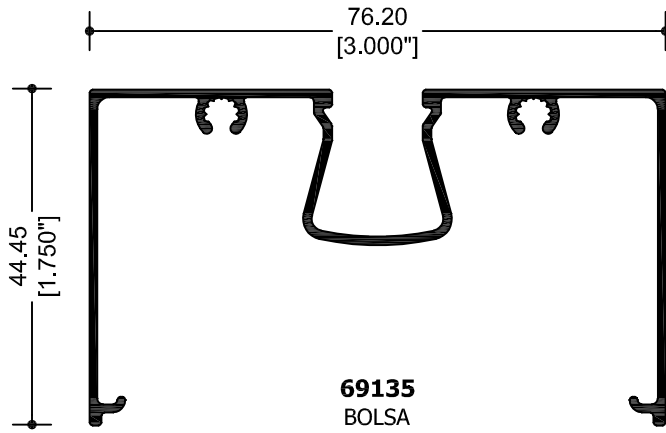

69135
BOLSA

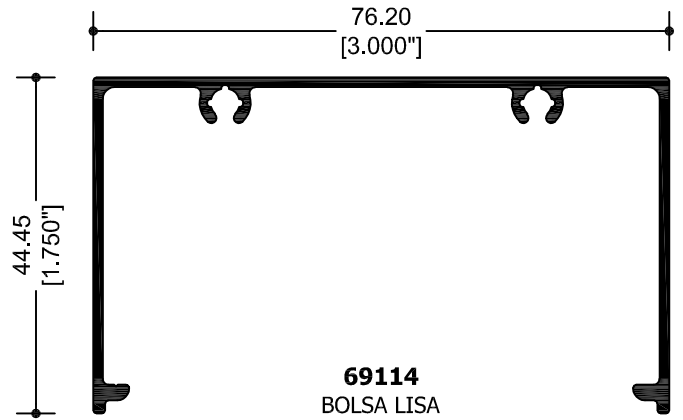

69114
BOLSA LISA

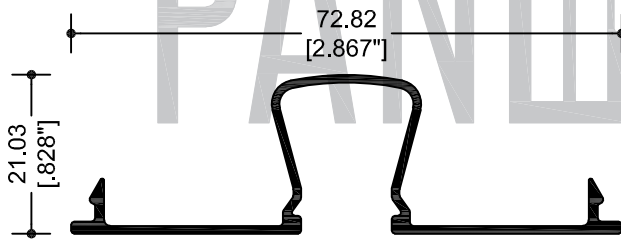

67315
TAPA BOLSA

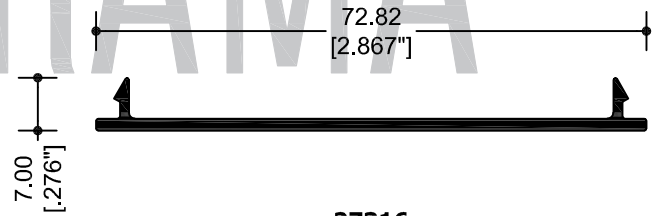

27316
TAPA LISA

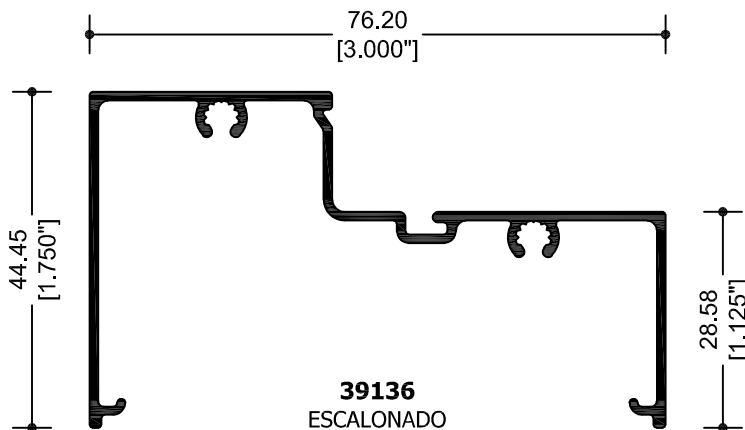

39136
ESCALONADO

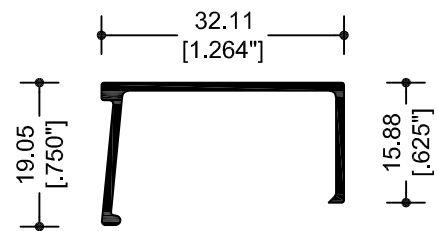

9112
JUNQUILLO

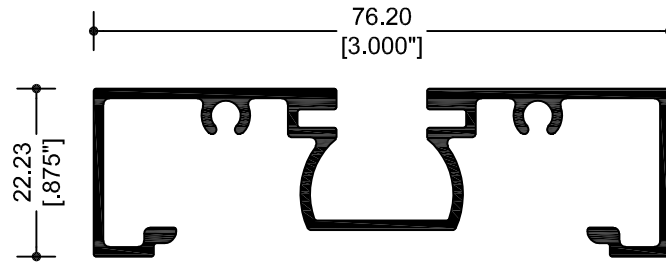

69105
BOLSA CORTA
SIN TEMPLE Y TEMPLE 05

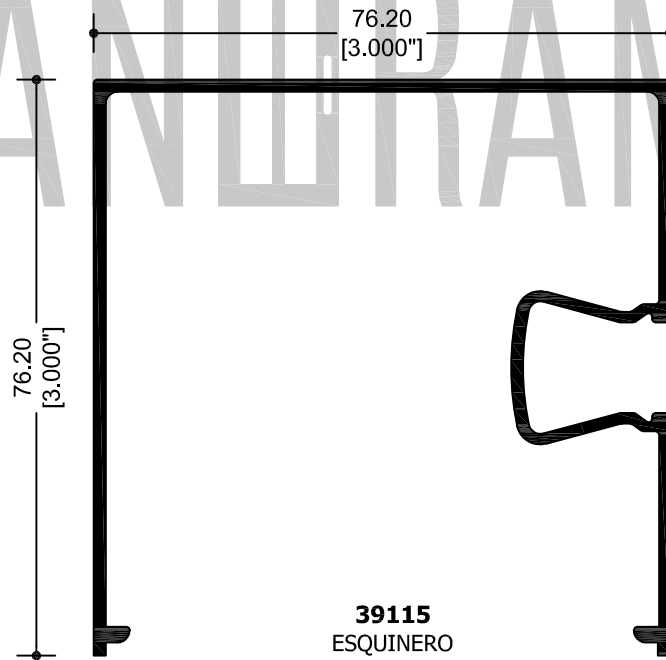
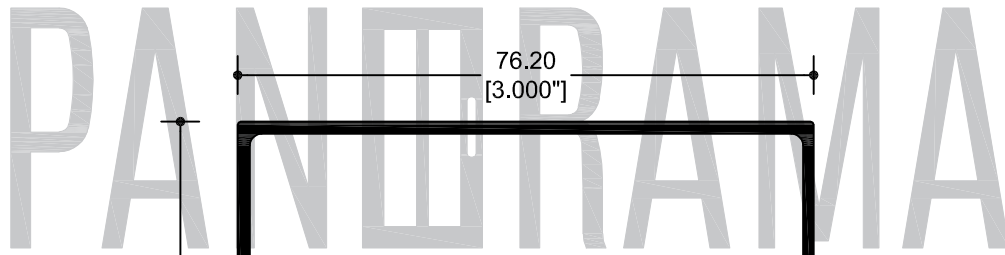

39115
ESQUINERO

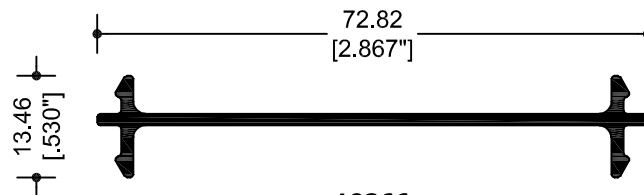

10266
MOLDURA DE UNIÓN
MULLION
SIN ACABADO

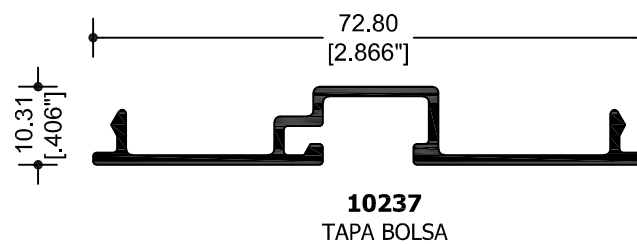
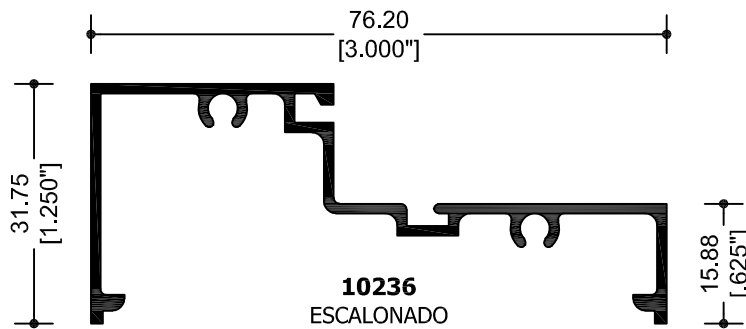
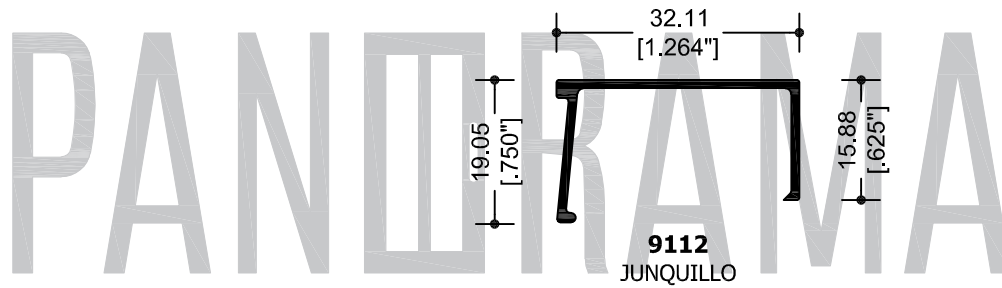
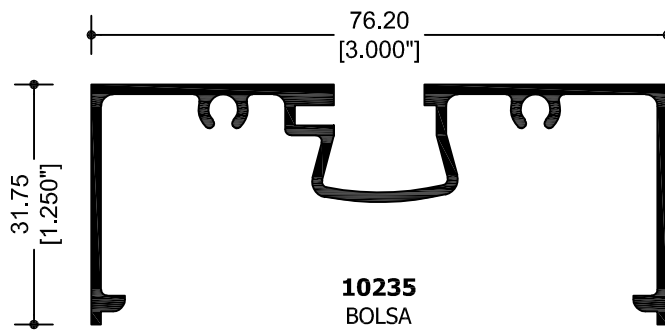

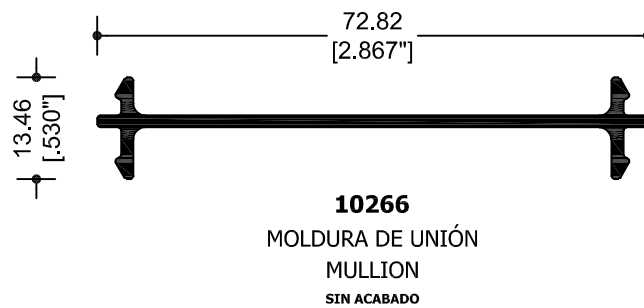
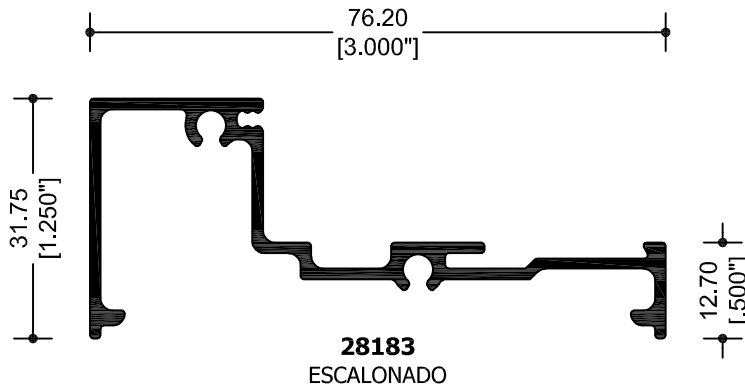
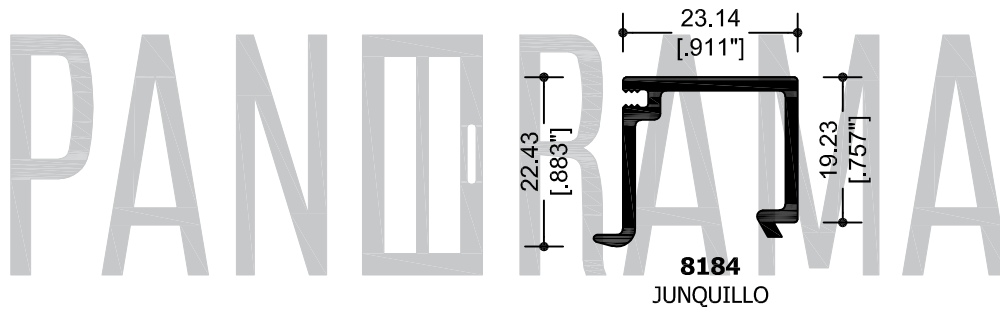
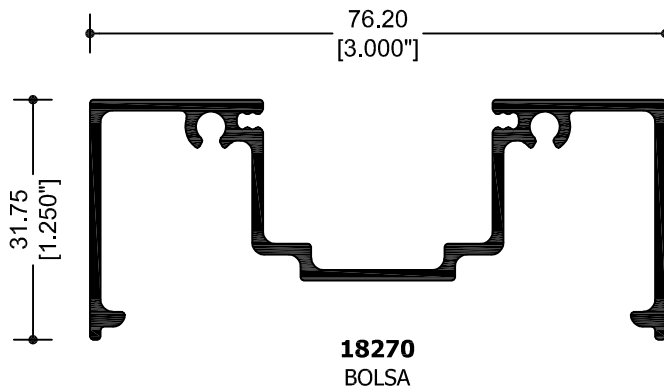

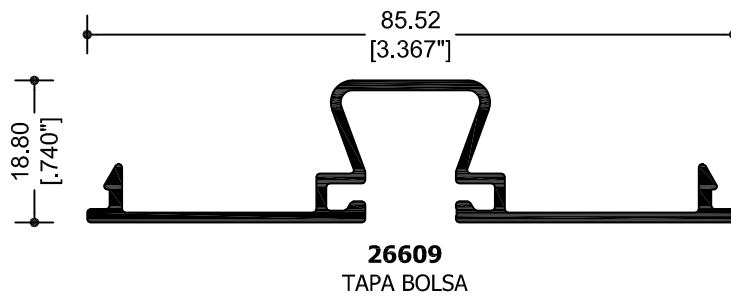
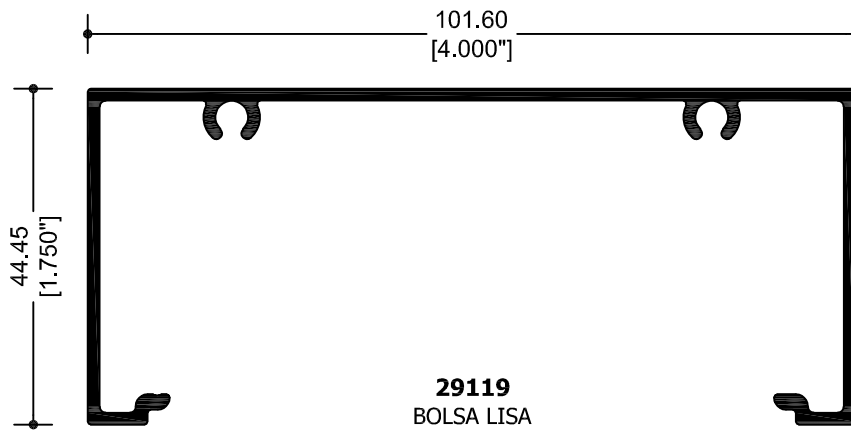
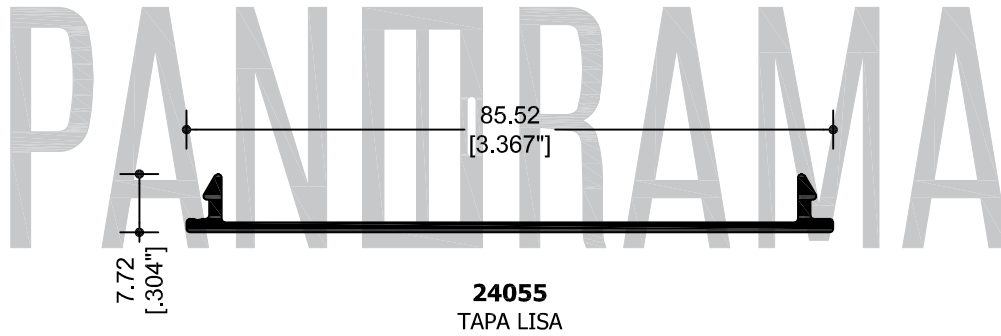
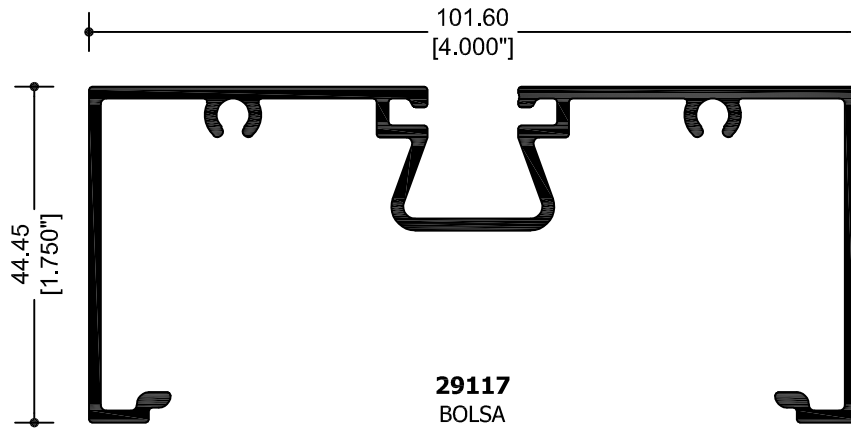

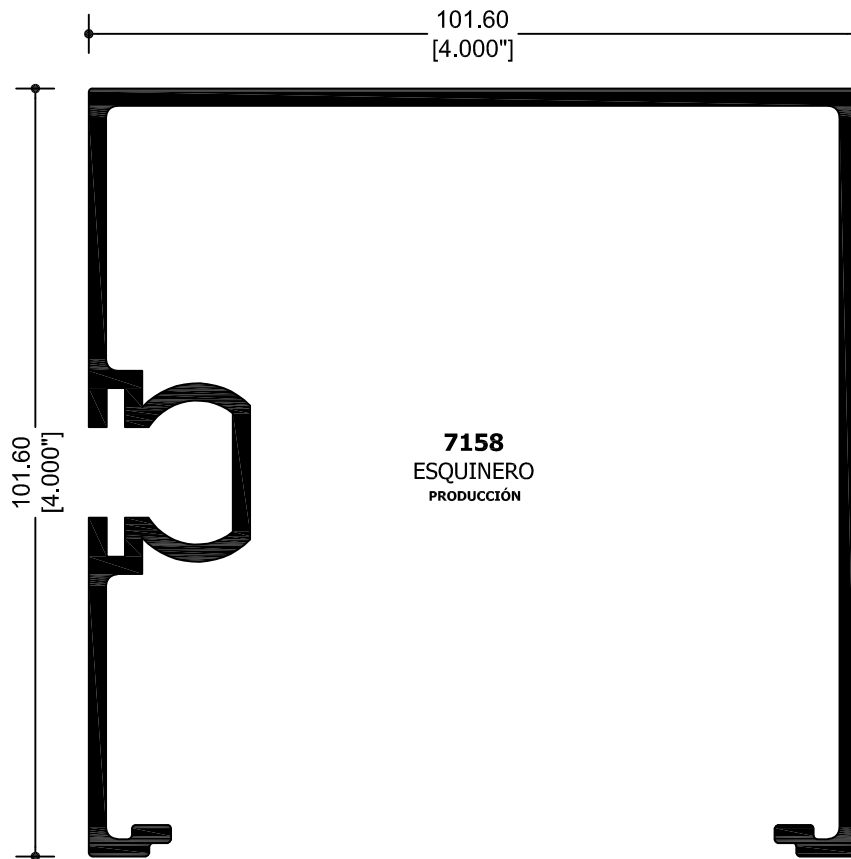
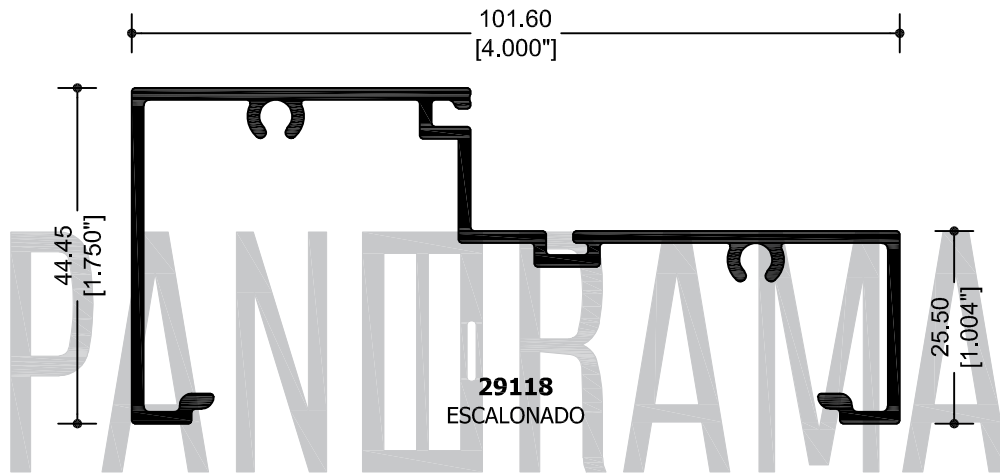
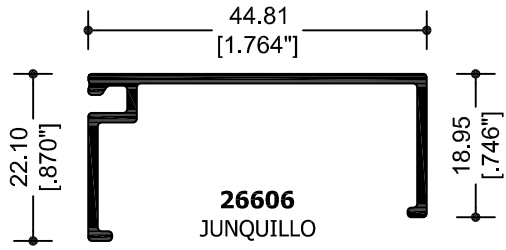

C-LIGHT IV

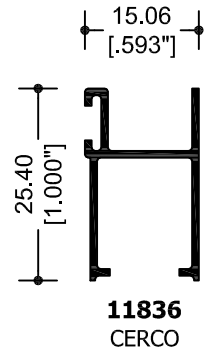
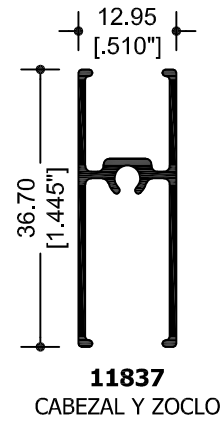
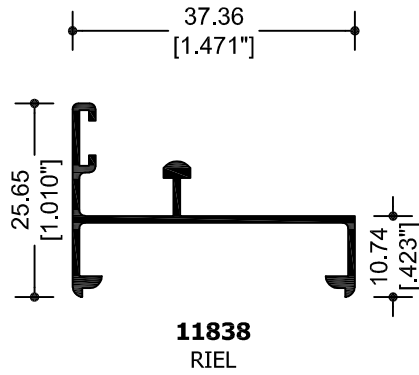
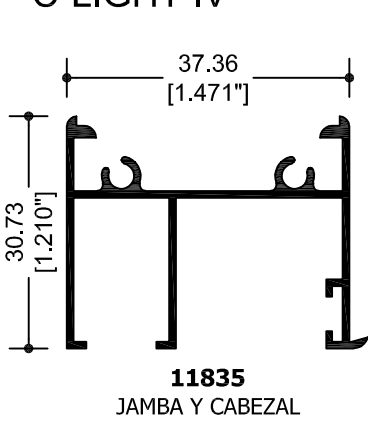

C-LIGHT V

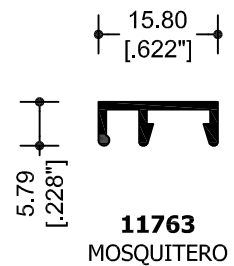
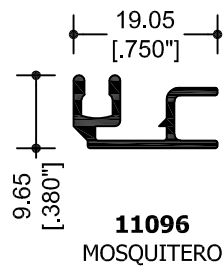
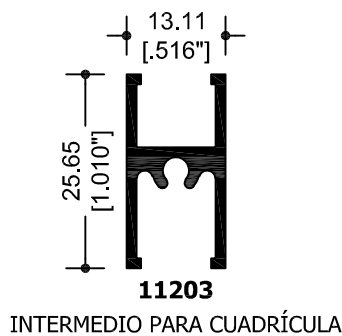
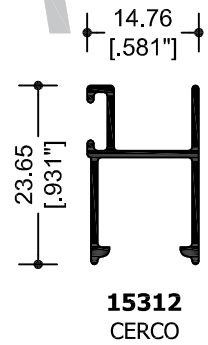
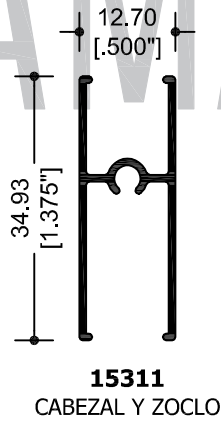
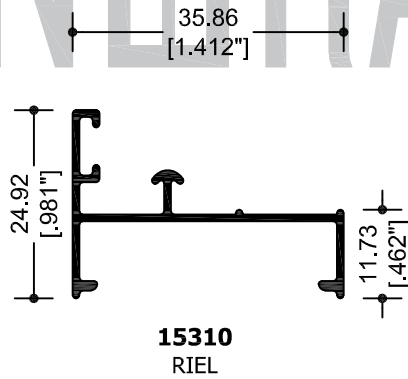
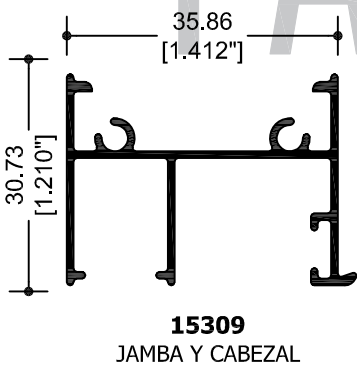

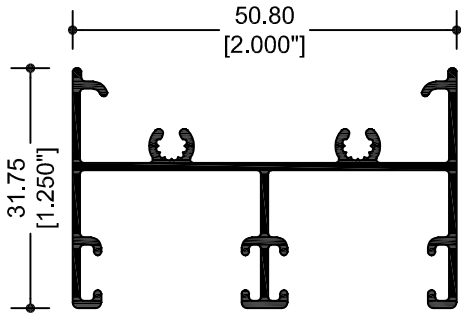

67518
CABEZAL Y JAMBA

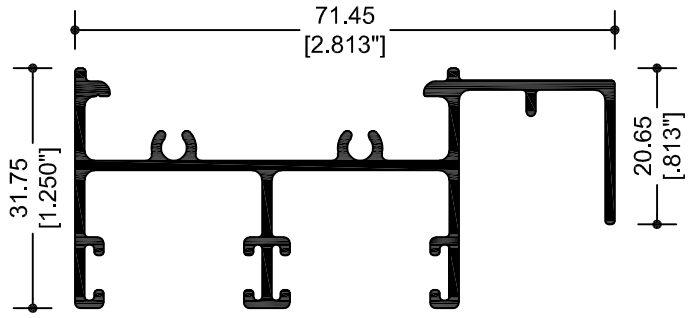

27819
CABEZAL MOS. CORREDIZO

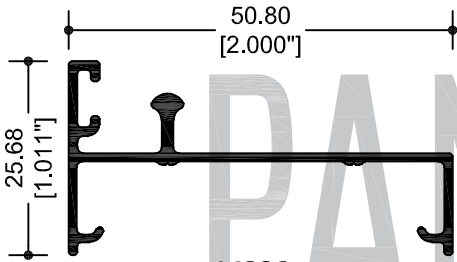

14286
RIEL

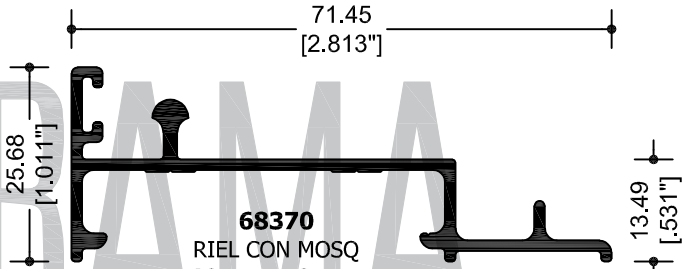

68370
RIEL CON MOSQ
CORREDIZO EXT.

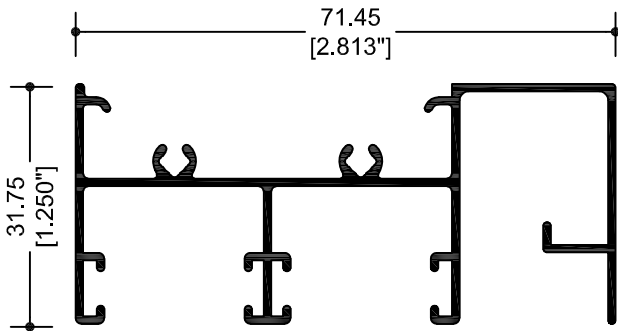

67819
CABEZAL MOSQUITERO COLGANTE

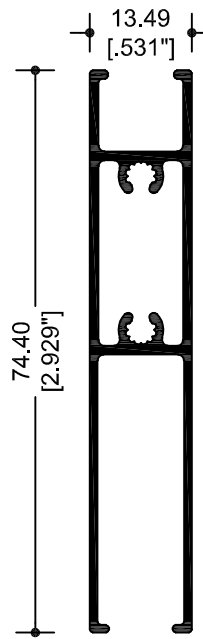

37825
ZOCLO PUERTA

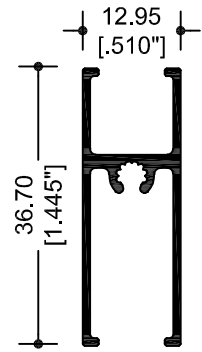

11044
CABEZAL Y ZOCLO

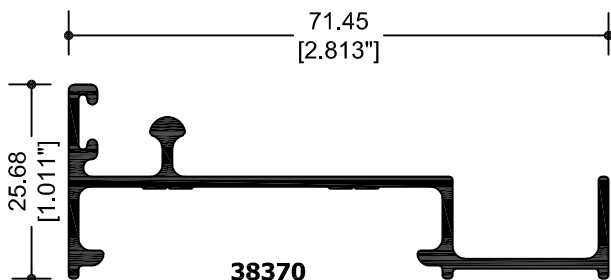

38370
RIEL CON MOSQ. EXT

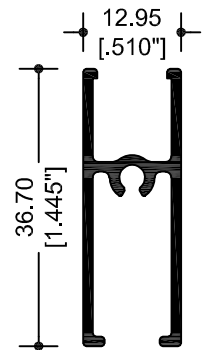

9956
CABEZAL Y ZOCLO

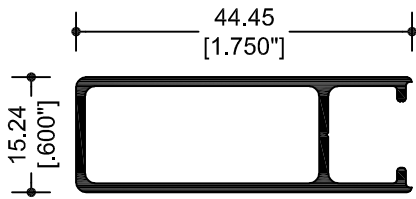

67821
CERCO PUERTA

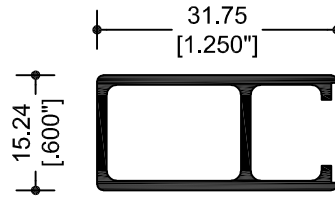

8320
CERCO VENTANA

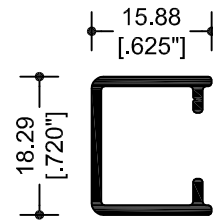

27525
CERCO FIJO ECONÓMICO

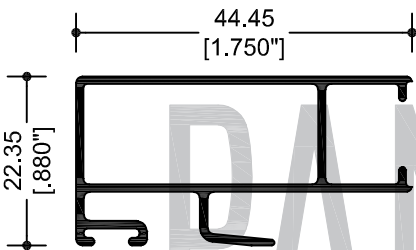

69955
TRASLAPE PUERTA

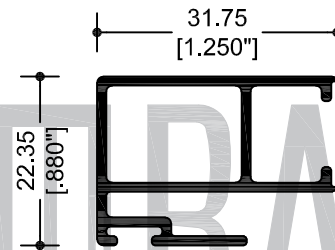

39954
TRASLAPE VENTANA

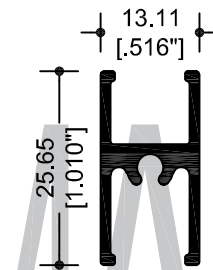

11203
INTERMEDIO PARA
CUADRÍCULA

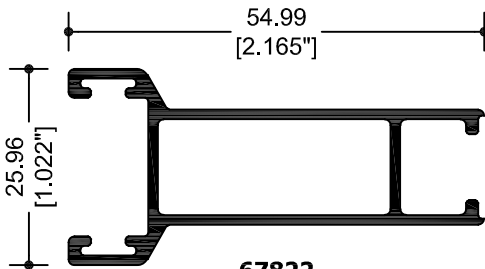

67822
CERCO OXO PUERTA

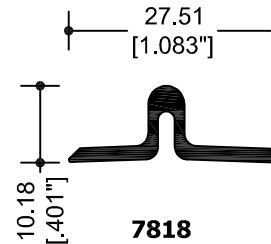

7818
ADAPTADOR XX

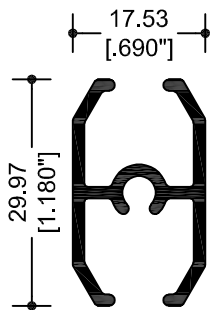

63728
PARA CUADRÍCULA
RECERCADO 2"

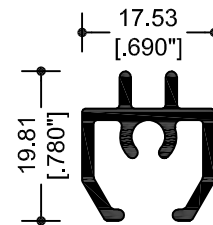

63727
BARROTILLO 2"

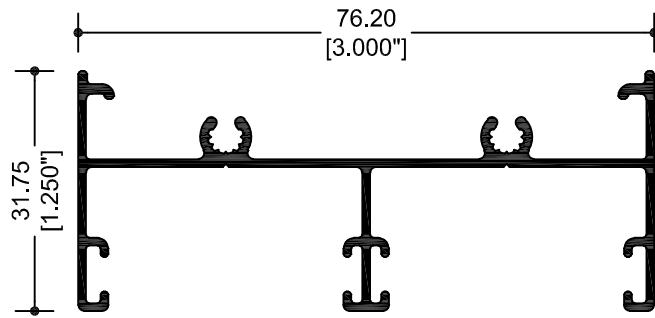

67826
CABEZAL Y JAMBA

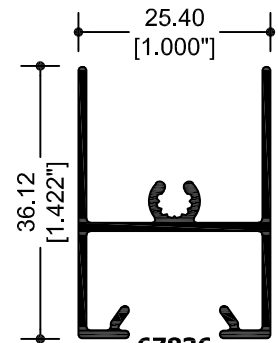

67836
CABEZAL VENTANA

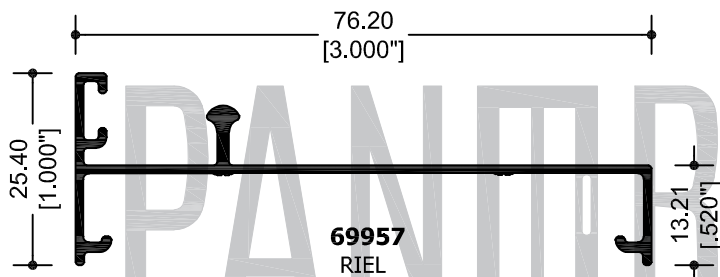

69957
RIEL

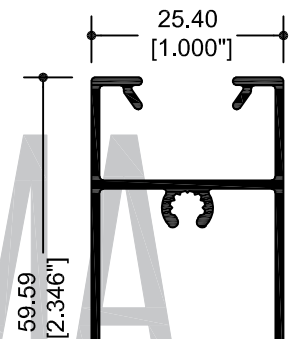

67835
ZOCLO VENTANA

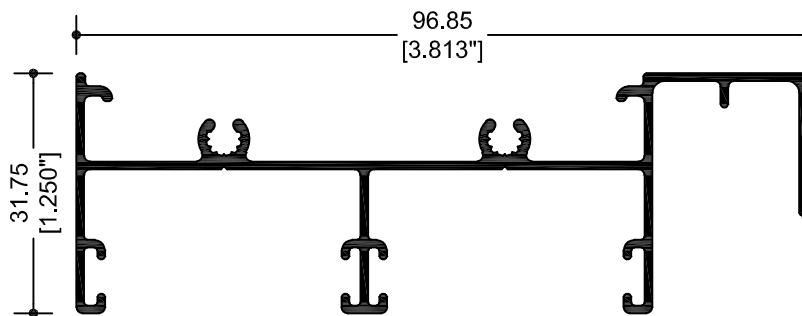

27862-77862
CABEZAL MOS. CORREDIZO

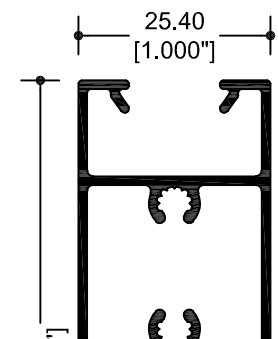

67842
ZOCLO PUERTA

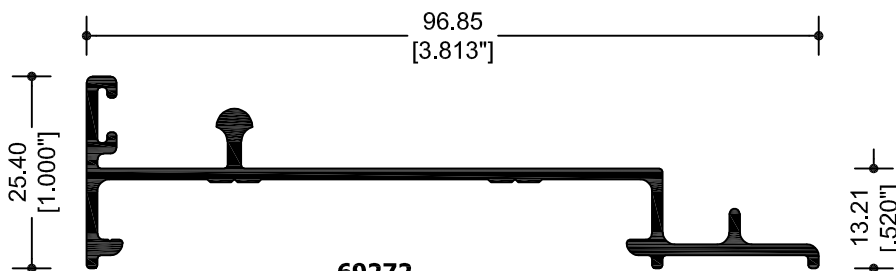

69272
RIEL PARA MOS. EXT. CORREDIZO

VENTANA Y PUERTA
CORREDIZA DE 3.000" X 1.250"

PANORAMA

CUPRUM

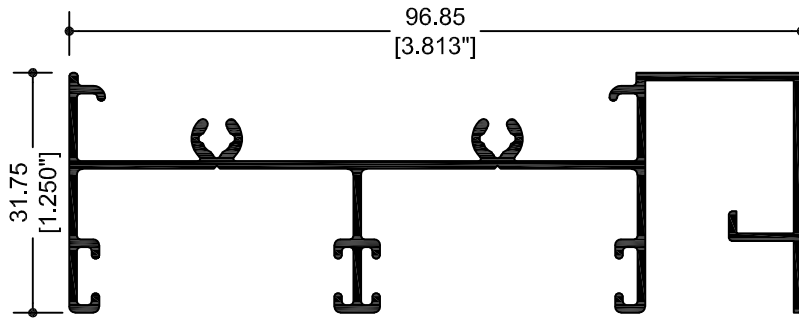

67862
CABEZAL MOSQUITERO COLGANTE

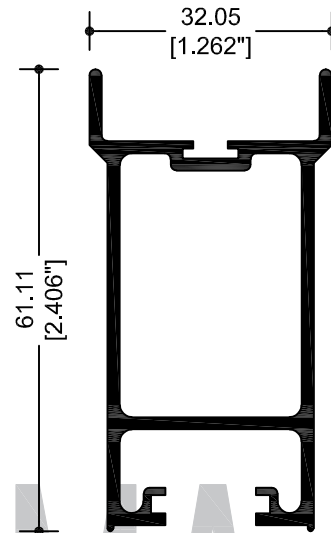

67850
CERCO OXXO

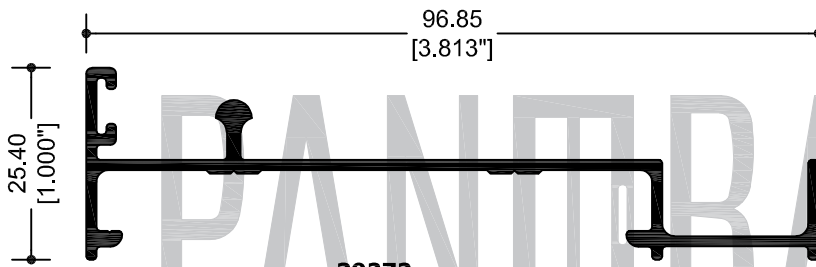

39272
RIEL PARA MOS. EXT. CORREDIZO

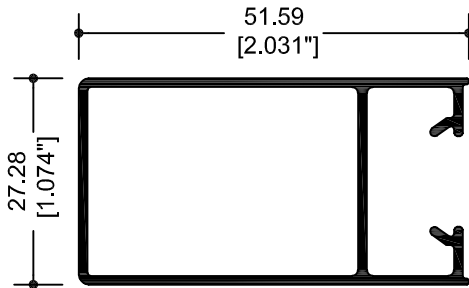

67847
CERCO CHAPA PUERTA

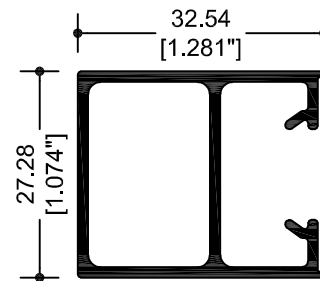

67843
CERCO VENTANA

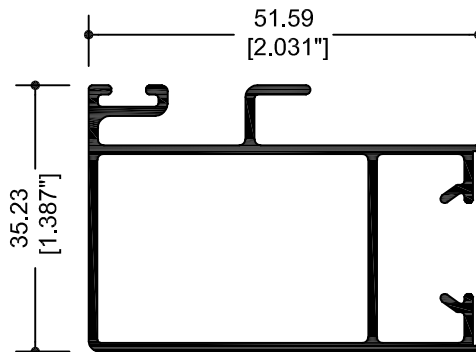

67848
TRASLAPE PUERTA

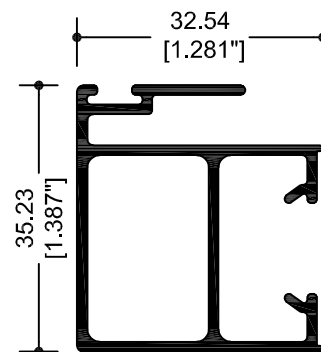

67844
CERCO TRASLAPE VENTANA

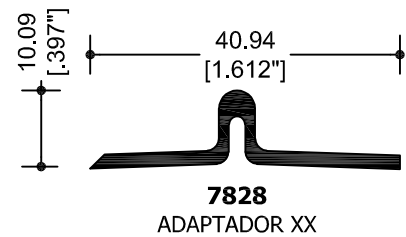
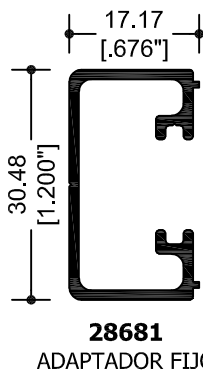
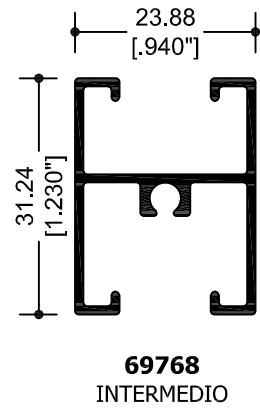
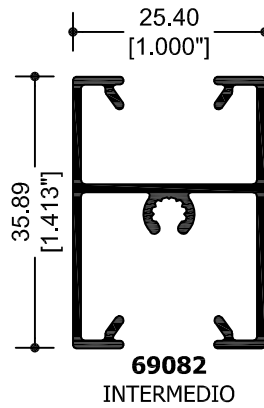
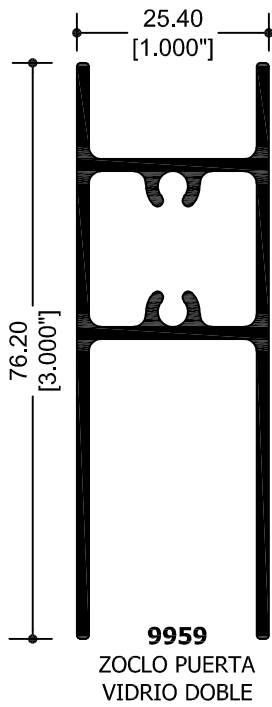
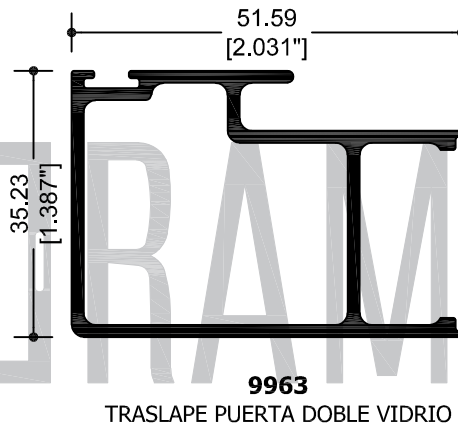
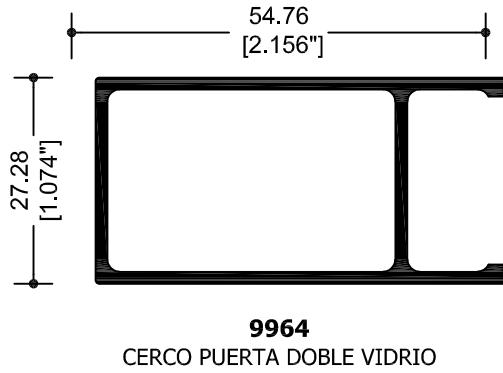
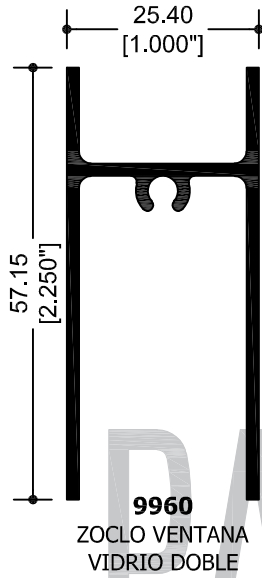

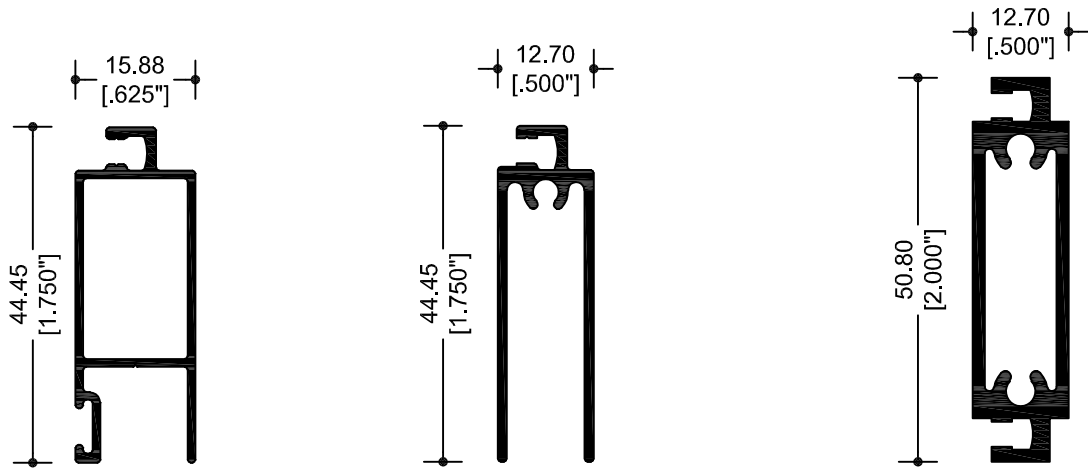

66534
CERCO MOSQUITERO

66533
CABEZAL Y ZOCLO
MOSQUITERO

7101
MOSQUITERO
INTERMEDIO

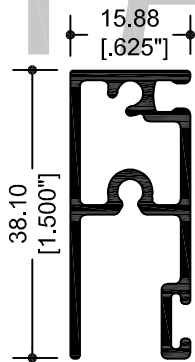

10358
MOSQUITERO

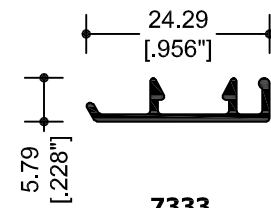

7333
MOSQUITERO

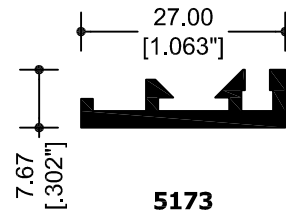

5173
MOSQUITERO

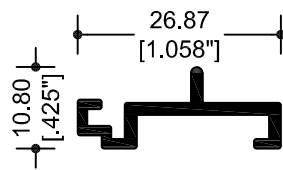

9966
ADAPTADOR MOSQUITERO

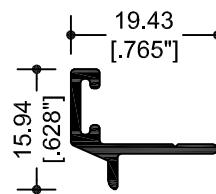

10220
ADAPTADOR OXXO

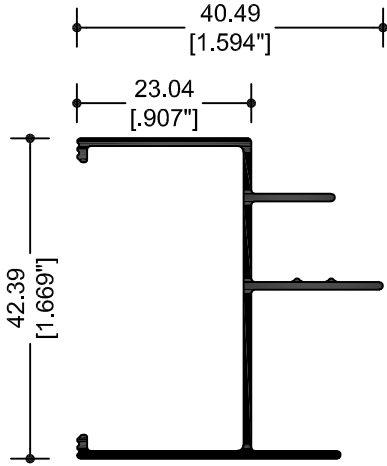

10570
JAMBA

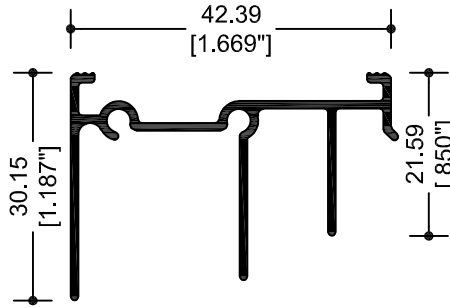

10568
CABEZAL

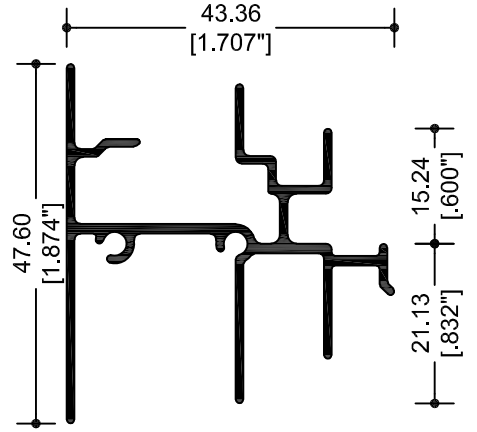

12797
RIEL Y CABEZAL

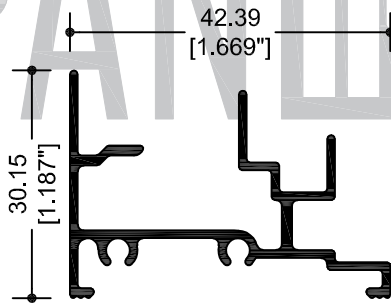
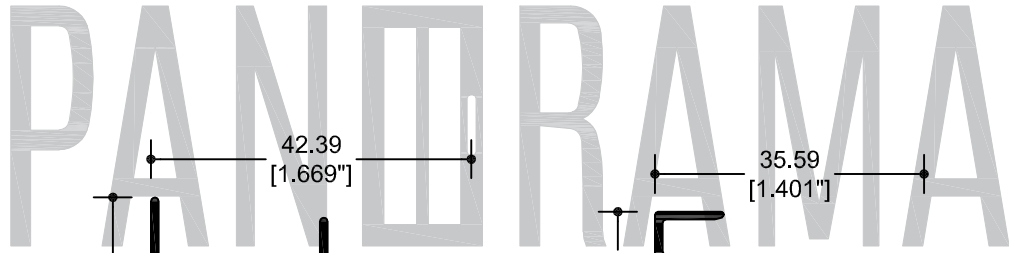

20569
RIEL

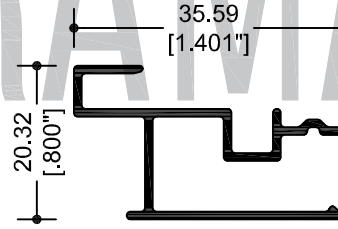

19272
TRASLAPE

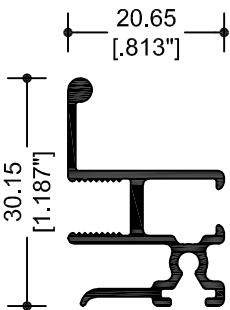

10571
CERCÓ MÓVIL

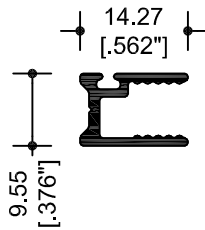

10574
CERCÓ FIJO

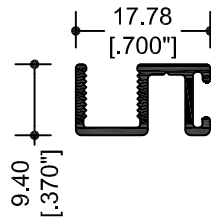

20572
CERCÓ Y ZOCLO

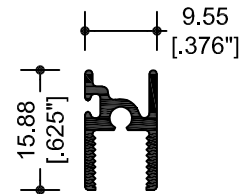

10575
ZOCLO

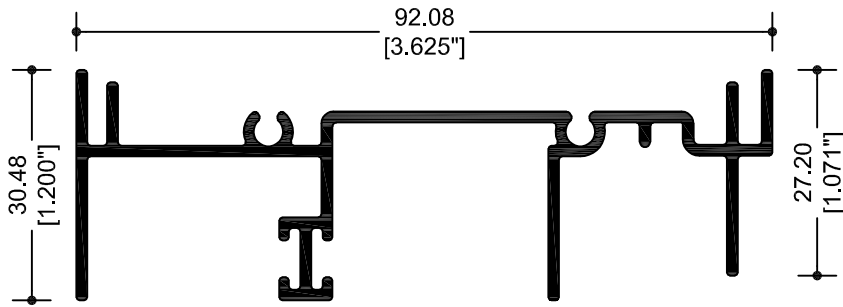

7109
CABEZAL CONTRAMARCO CORREDIZA

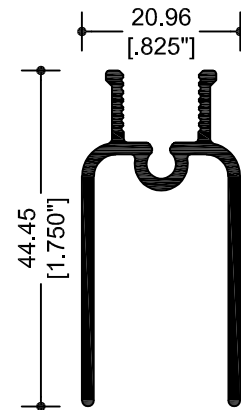

7108
CABEZAL Y ZOCLO

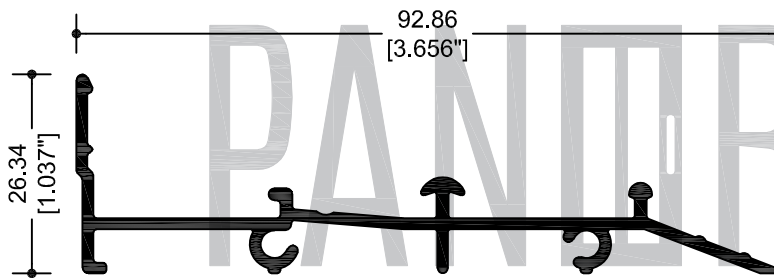

7110
RIEL CONTRAMARCO CORREDIZO

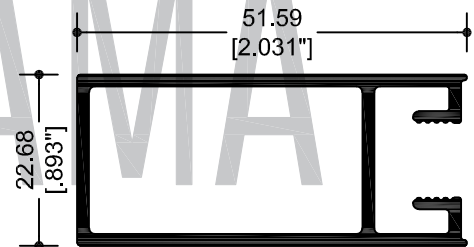

7105
CERCO CHAPA

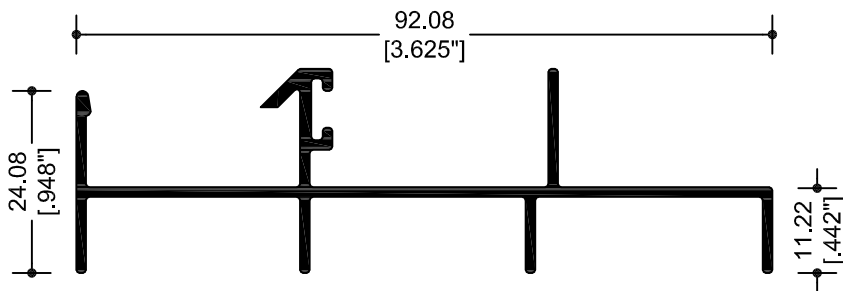

27111
JAMBA PARA CORREDIZA

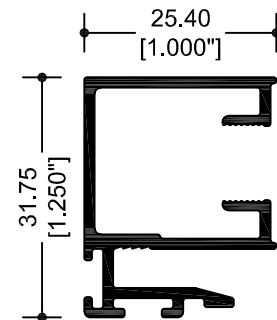

7106
CERCO TRASLAPE

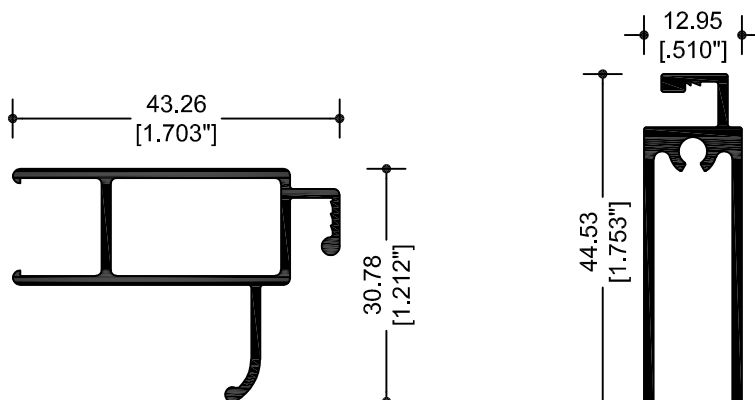

7112
VERTICAL MOSQUITERO

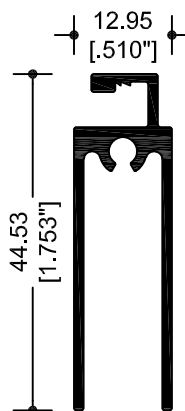

7104
MOSQUITERO

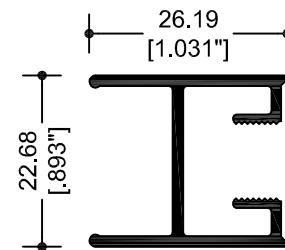

7107
CERCO FIJO

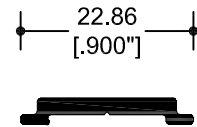
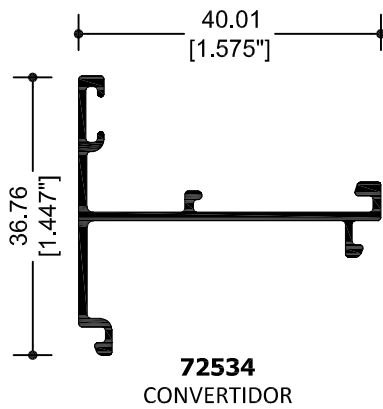
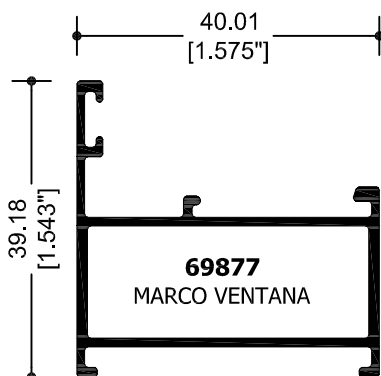
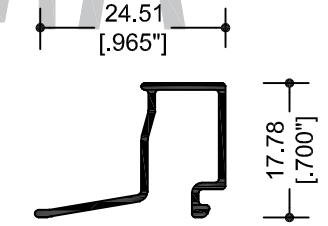
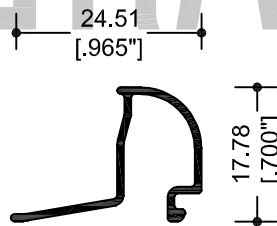
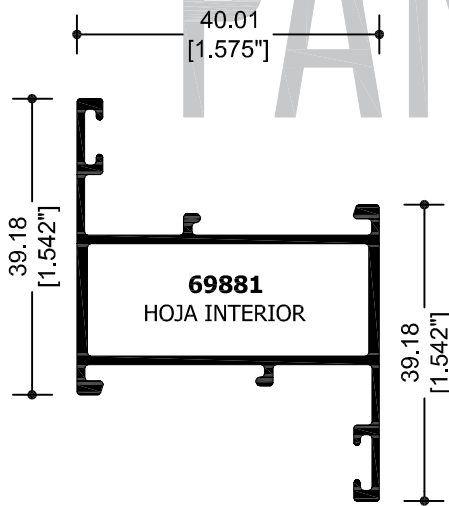
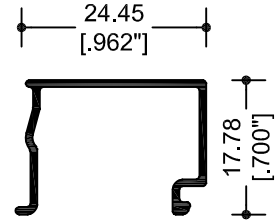
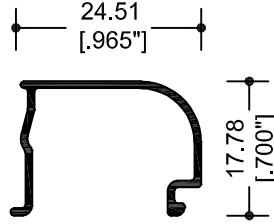
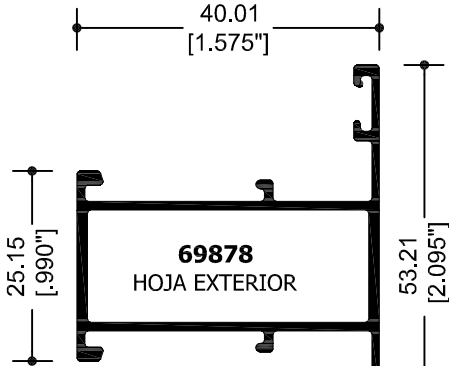

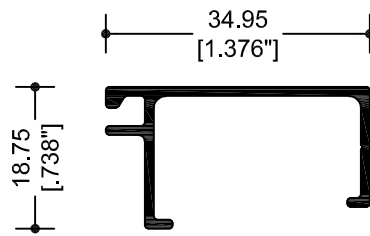

28939
JUNQUILLO

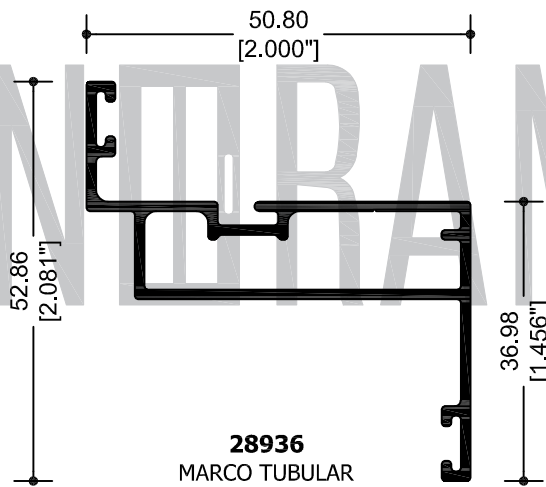

28936
MARCO TUBULAR

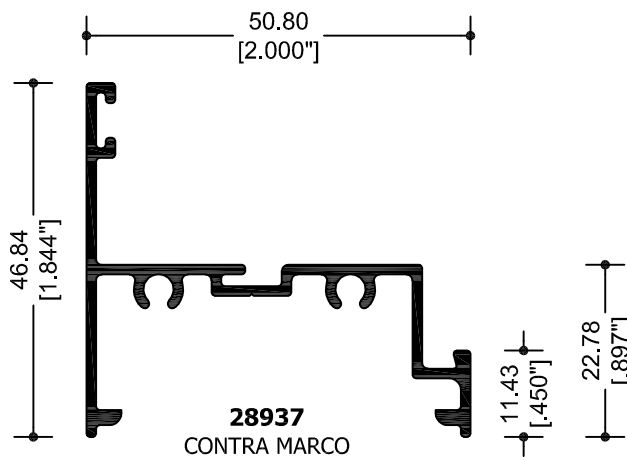

28937
CONTRA MARCO

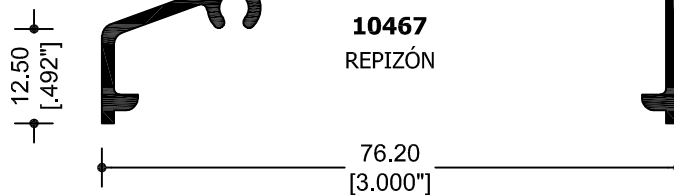
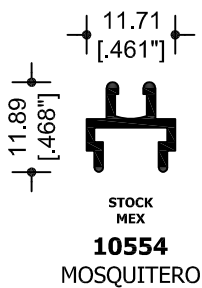
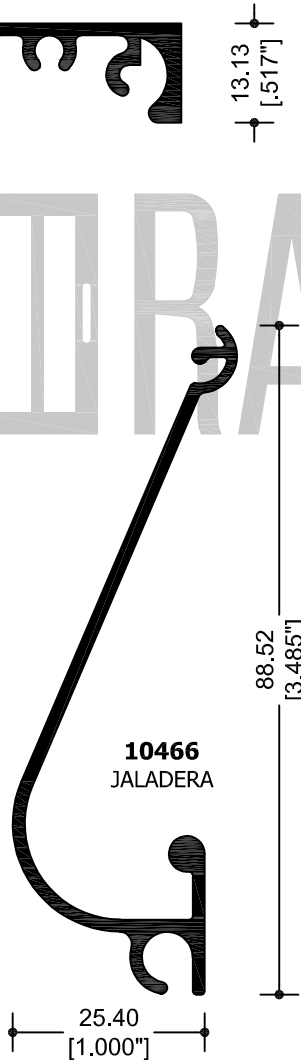
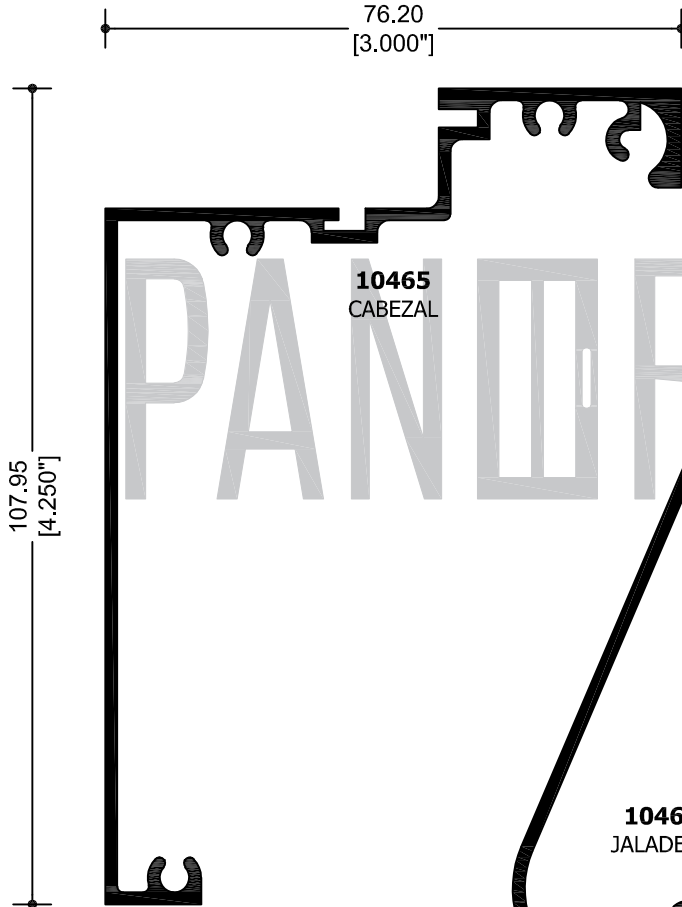
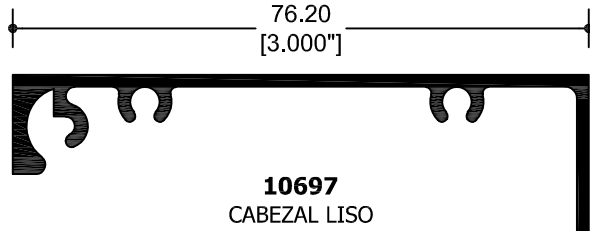
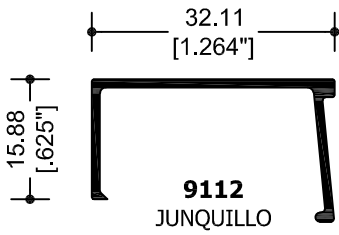

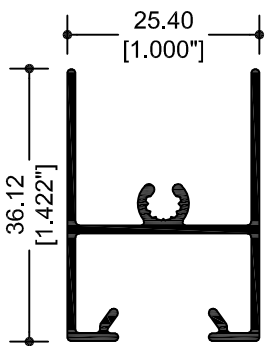

67836
CABEZAL

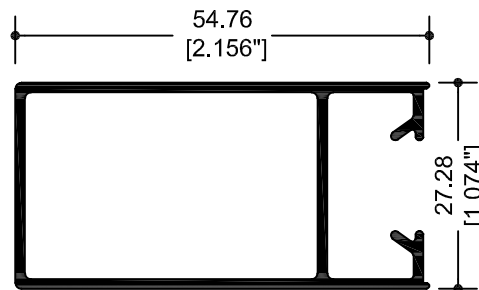

9236
CERCO CHAPA

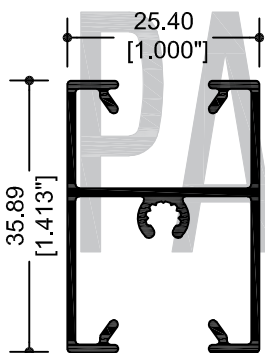

69082
INTERMEDIO

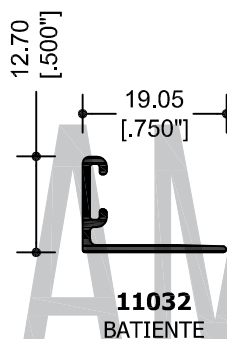

11032
BATIENTE

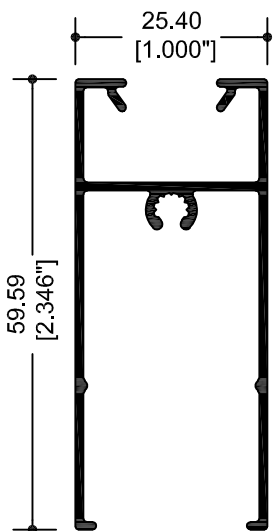

67835
ZOCLO

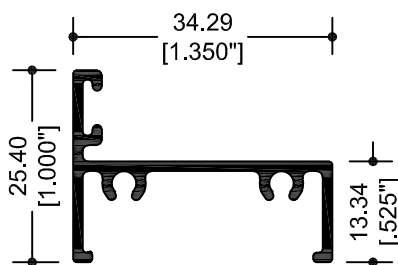

33087
MARCO PARA PUERTA

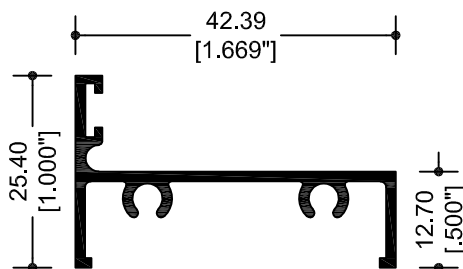

68550
MARCO PARA PUERTA

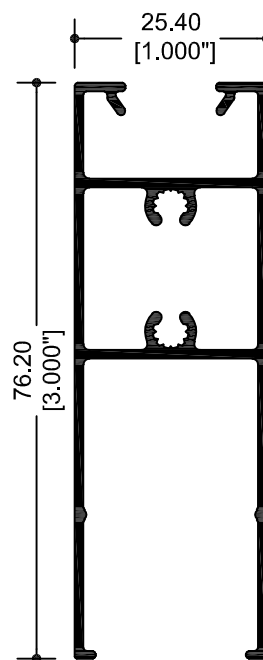

67842
ZOCLO

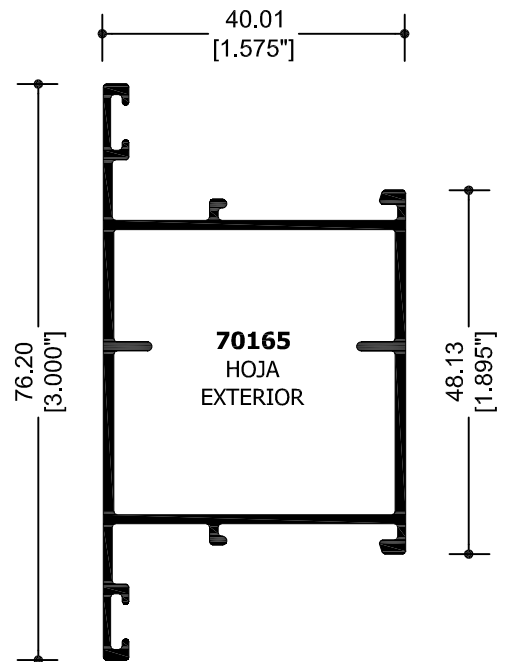
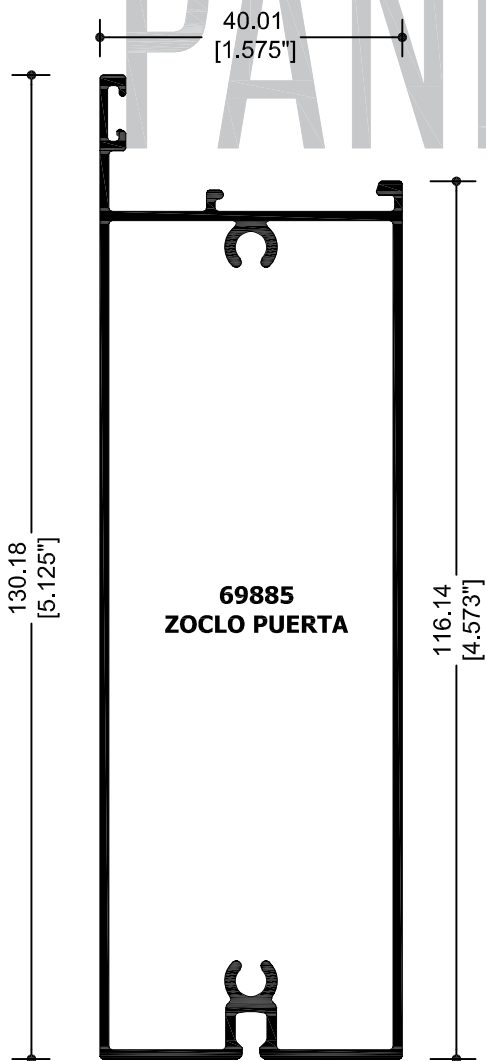
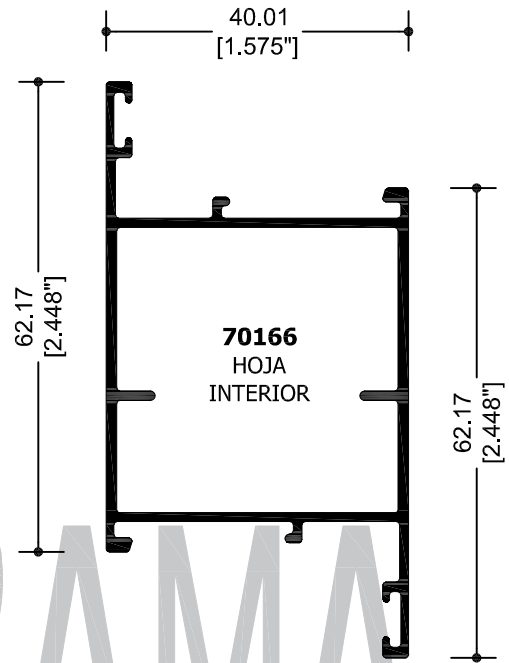
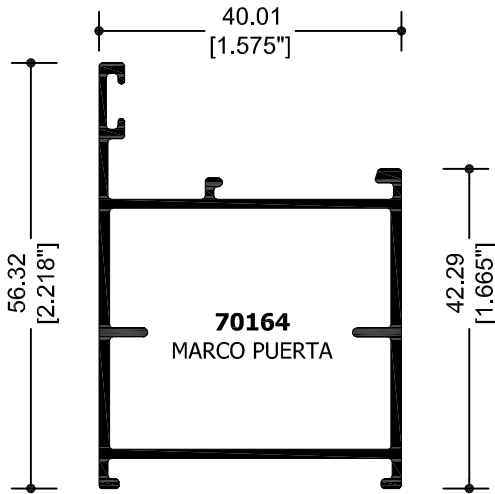

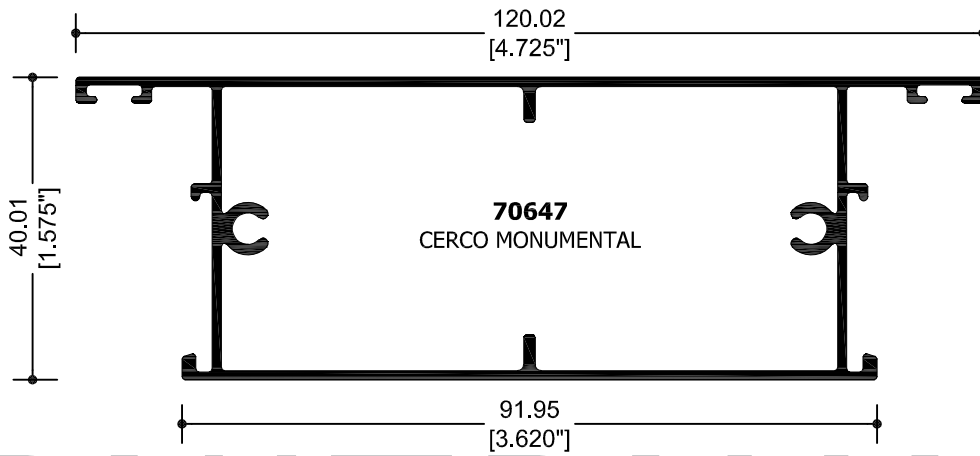

PANORAMA

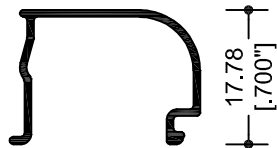

69891

JUNQUILLO CONCAVO
SENCILLO (6mm)

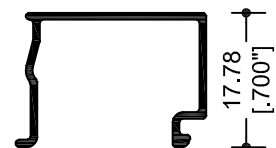

69890

JUNQUILLO CUADRADO
SENCILLO (6mm)

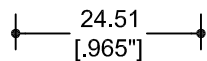

69887

JUNQUILLO CONCAVO
DOBLE (18mm)

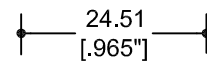

69888

JUNQUILLO CUADRADO
DOBLE (18mm)

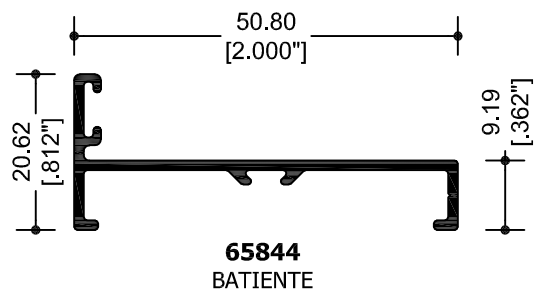
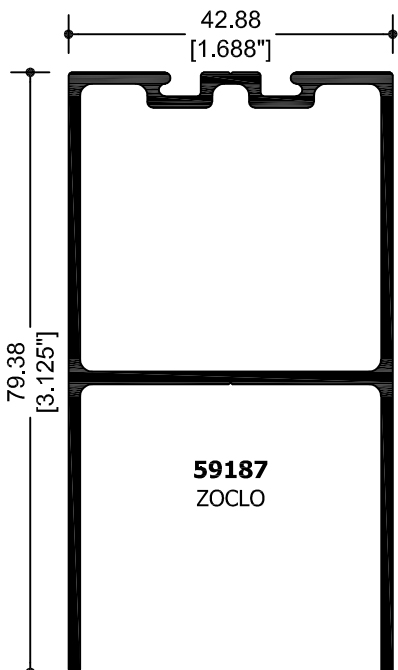
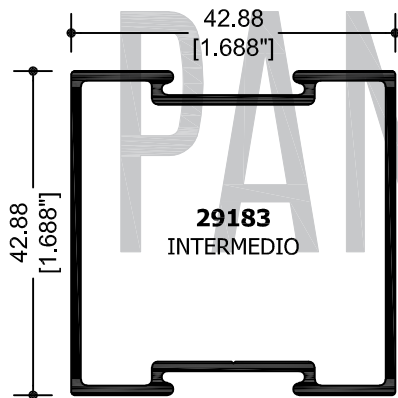
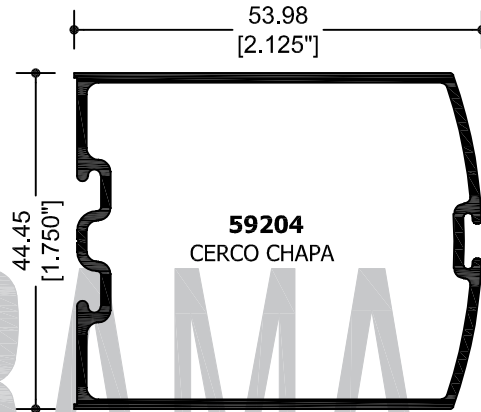
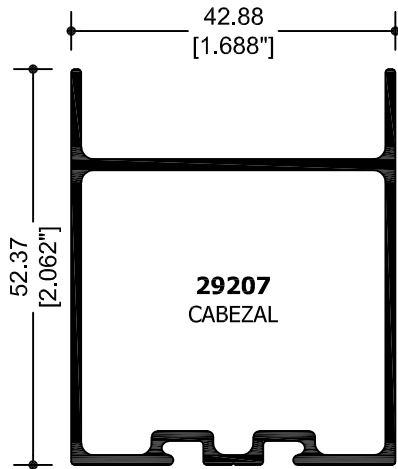

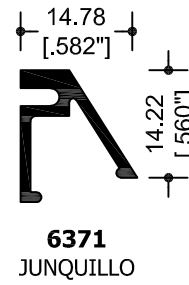
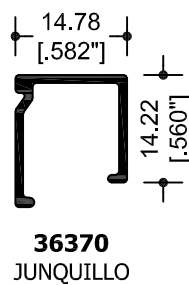
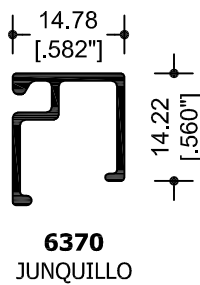
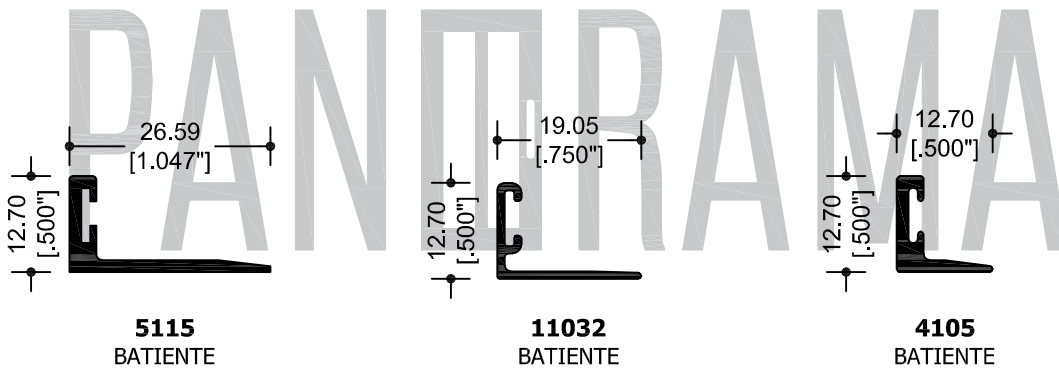
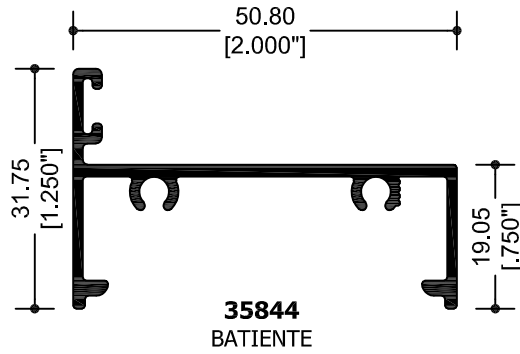

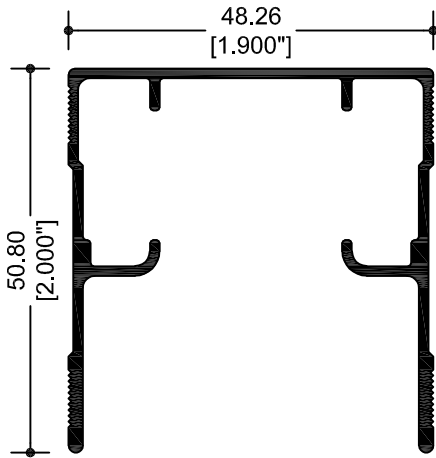

9947
RIEL SUPERIOR

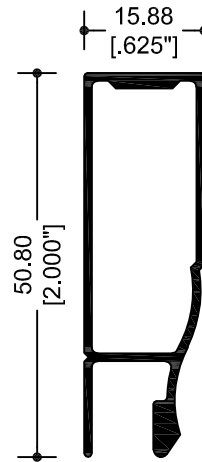

10103
MARCO 2"

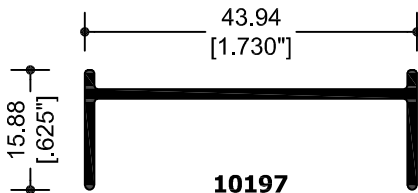

10197
JAMBA LATERAL

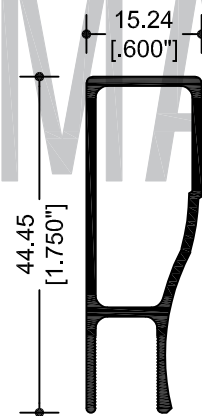

9756
MARCO 1 3/4"

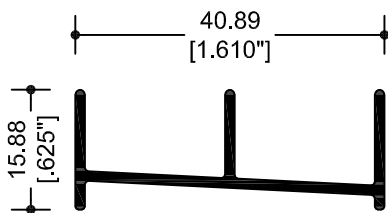

10198
RIEL INFERIOR

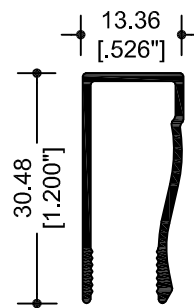

13563
MARCO 1 1/4"

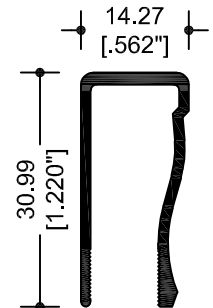

9525
MARCO 1 1/4"

PANORAMA

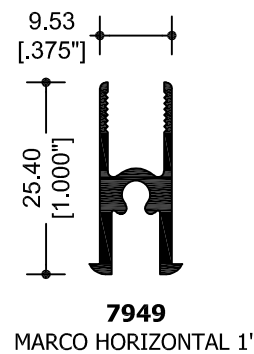
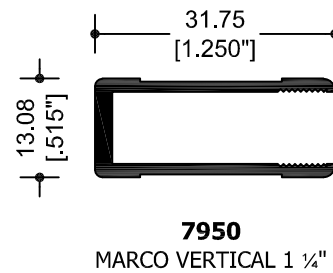
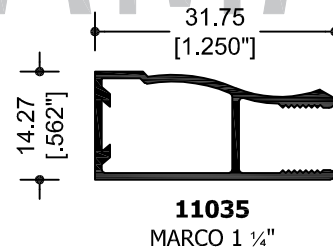
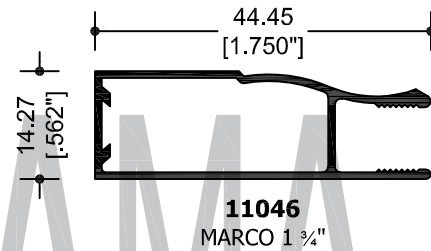
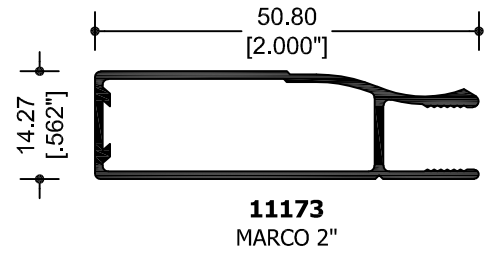
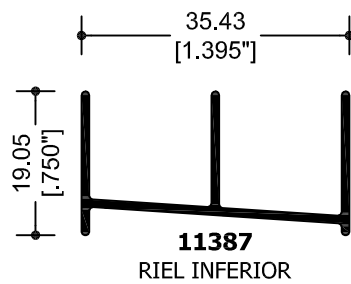
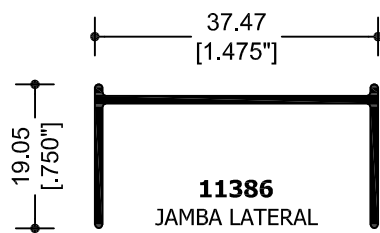
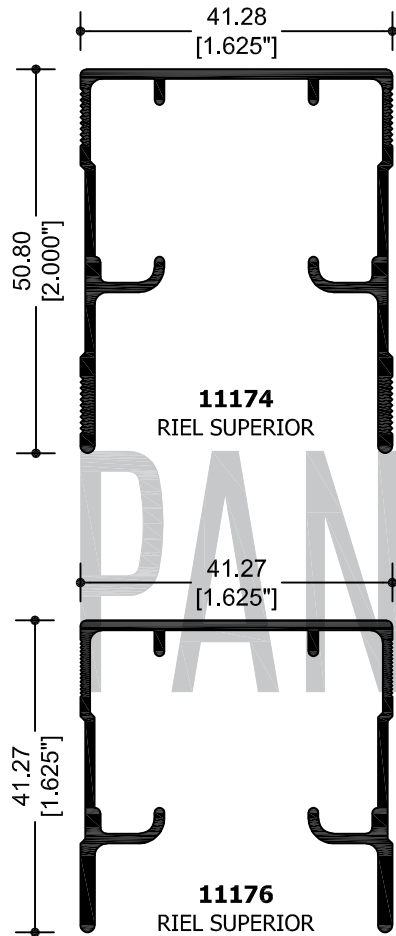

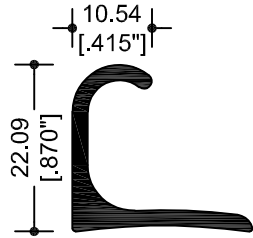

4154
JALADERA

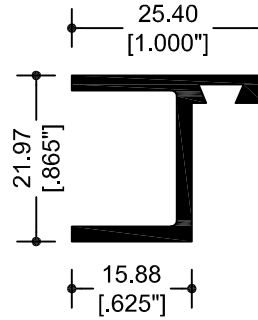

7102
BATIENTE

PANORAMA

APARADORES Y VITRINAS

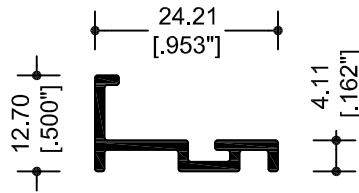

67013
BASE

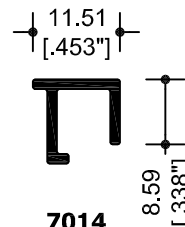

7014
JUNQUILLO

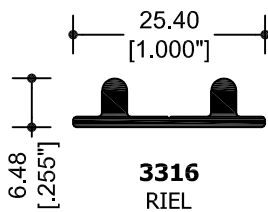

3316
RIEL

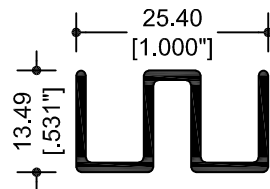

63329
GUÍA

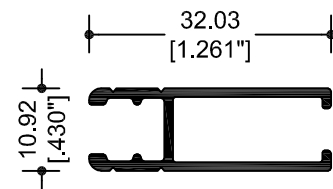

53358
ZAPATA

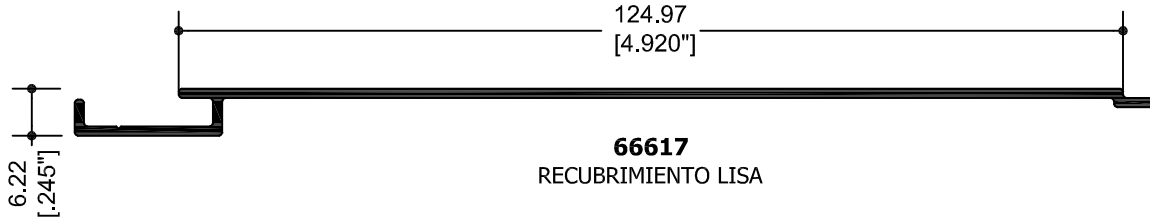

66617
RECUBRIMIENTO LISA

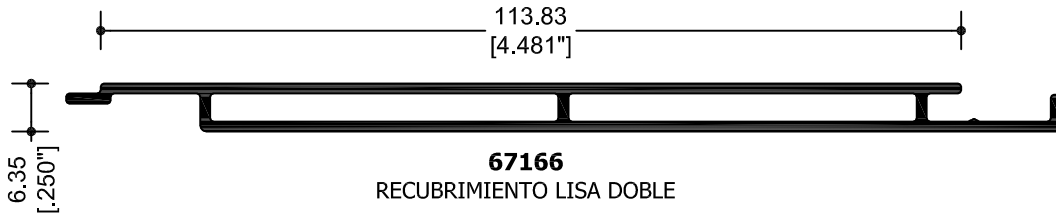

67166
RECUBRIMIENTO LISA DOBLE

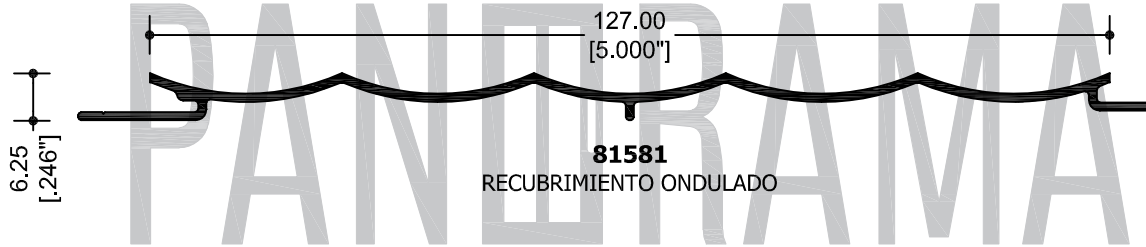

81581
RECUBRIMIENTO ONDULADO

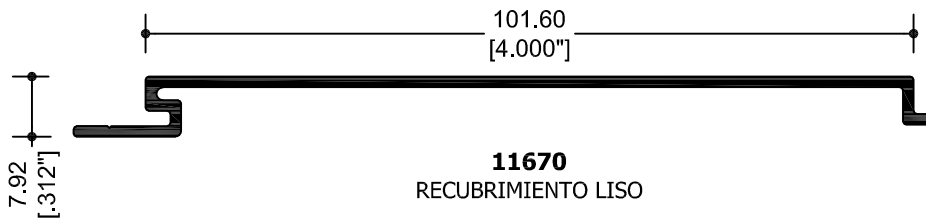

11670
RECUBRIMIENTO LISO

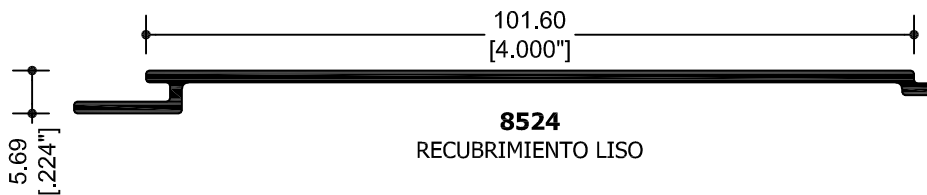

8524
RECUBRIMIENTO LISO

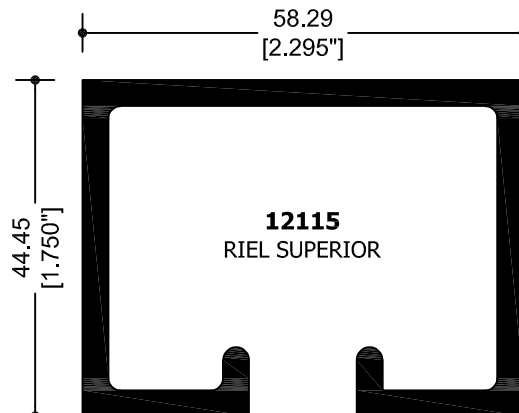

12115
RIEL SUPERIOR

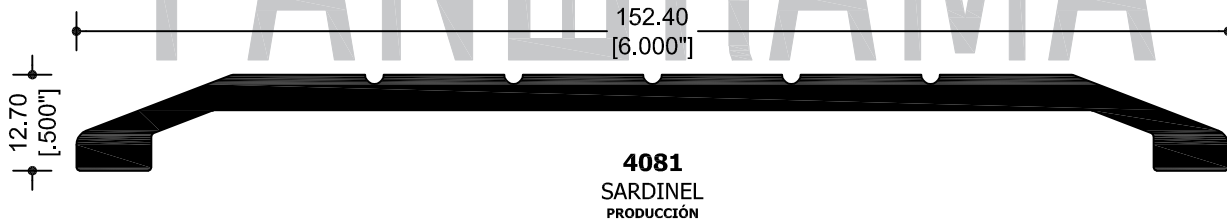
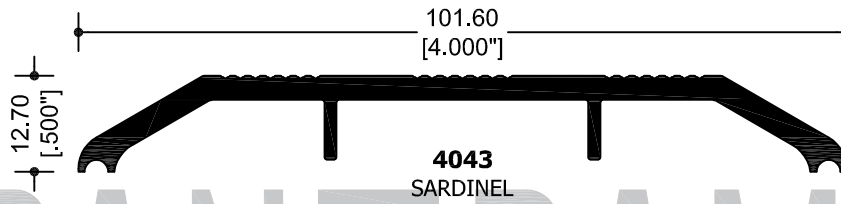
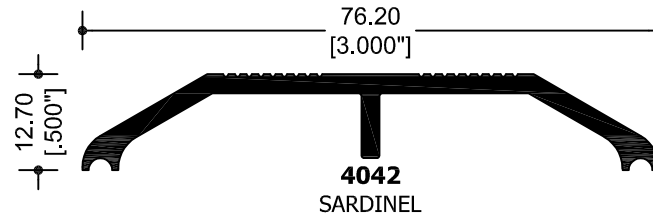

REPIZÓN

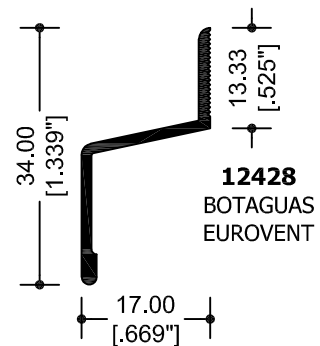
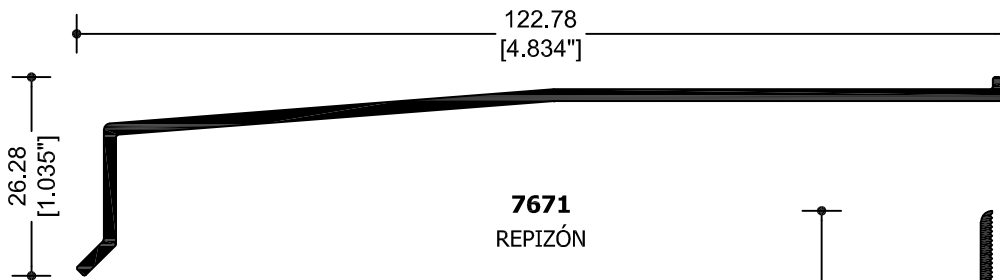

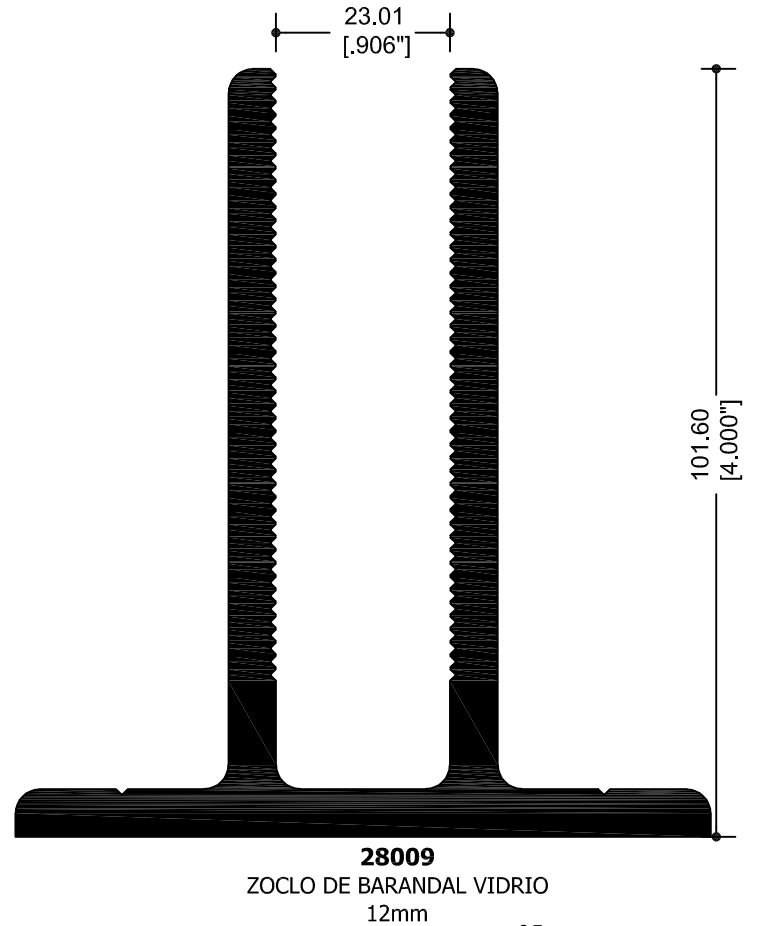
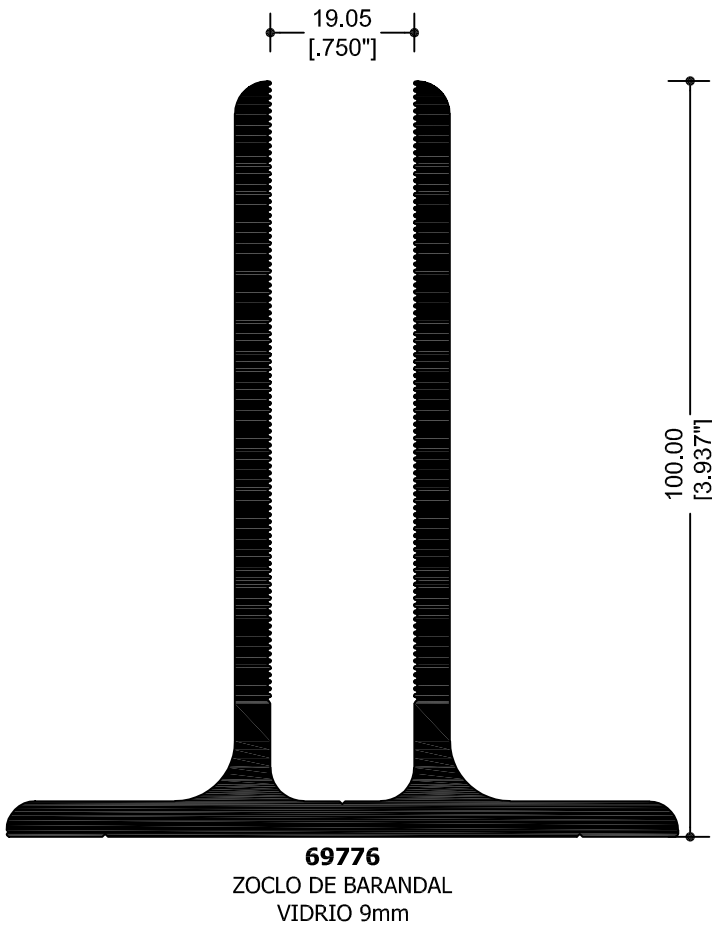
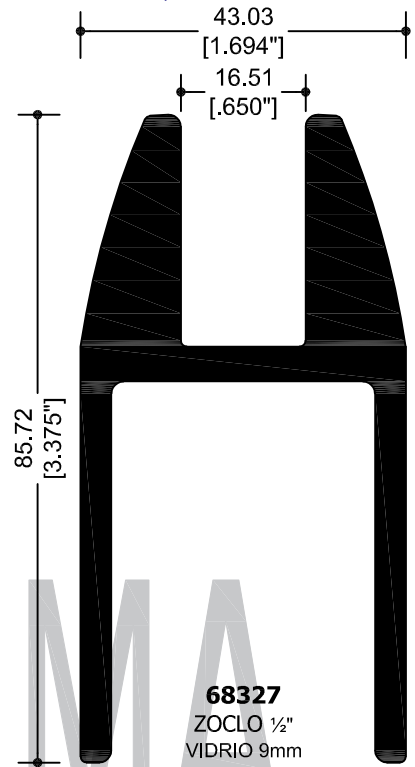
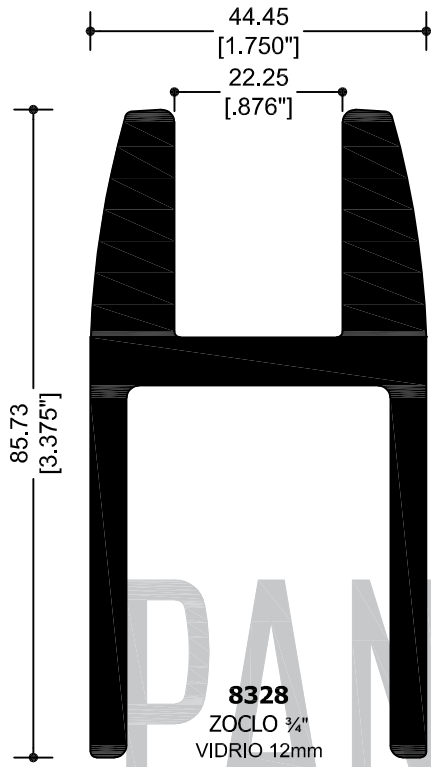

60.00
[2.362"]



13.51
[.532"]

76.20
[3.000"]

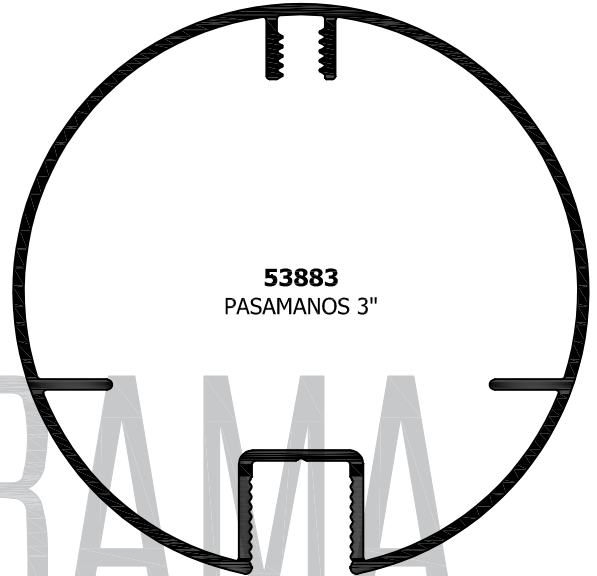

13.00
[.512"]

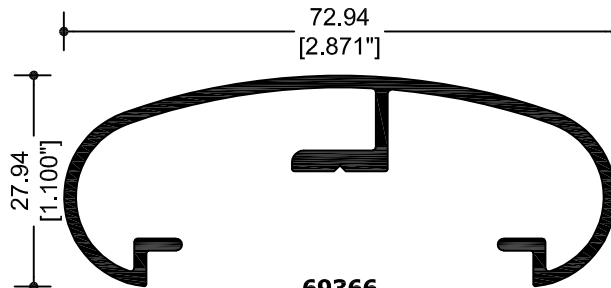

50.80
[2.000"]



4.76
[.188"]

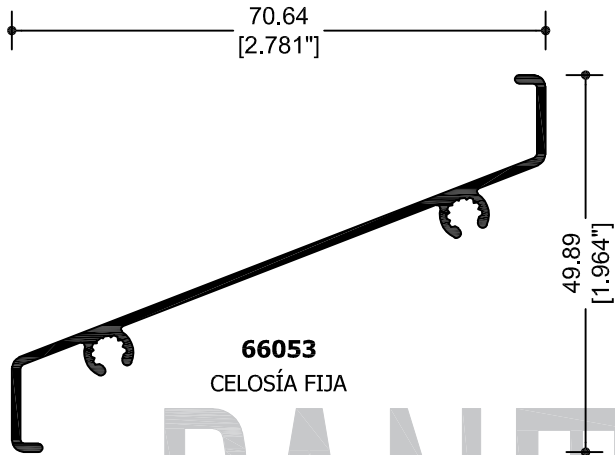

66053
CELOSÍA FIJA

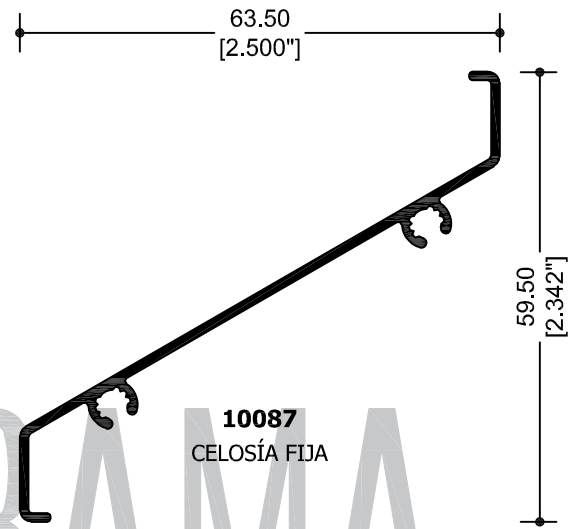

10087
CELOSÍA FIJA

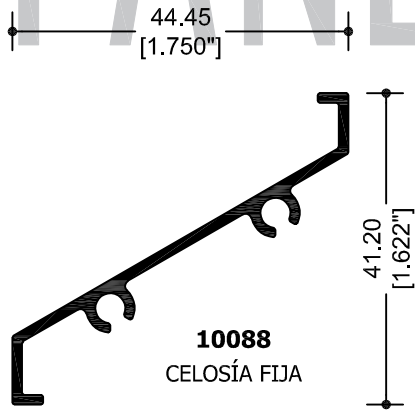

10088
CELOSÍA FIJA

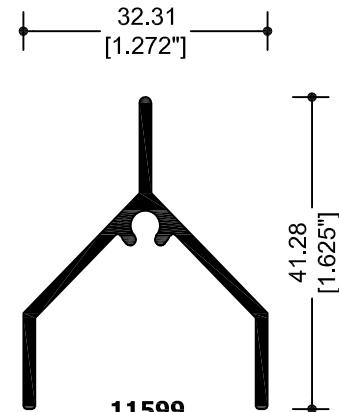

11599
REJILLA

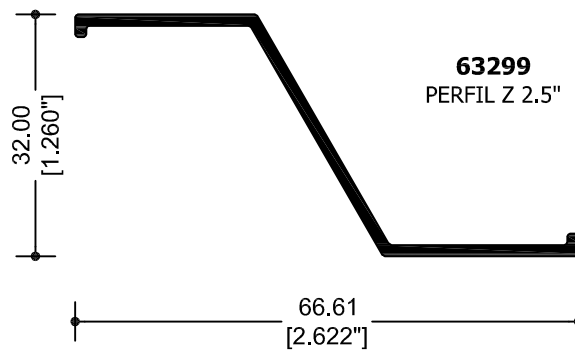

63299
PERFIL Z 2.5"

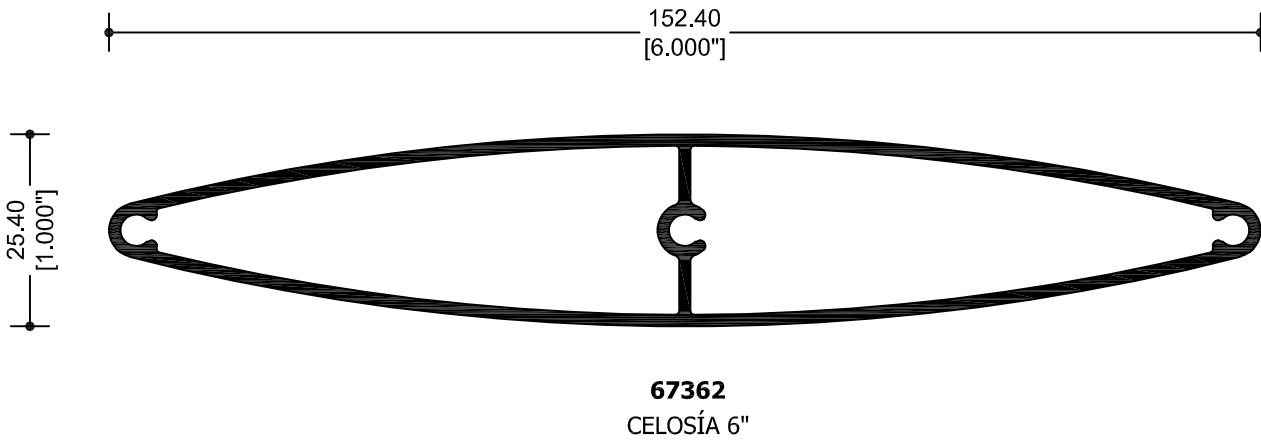
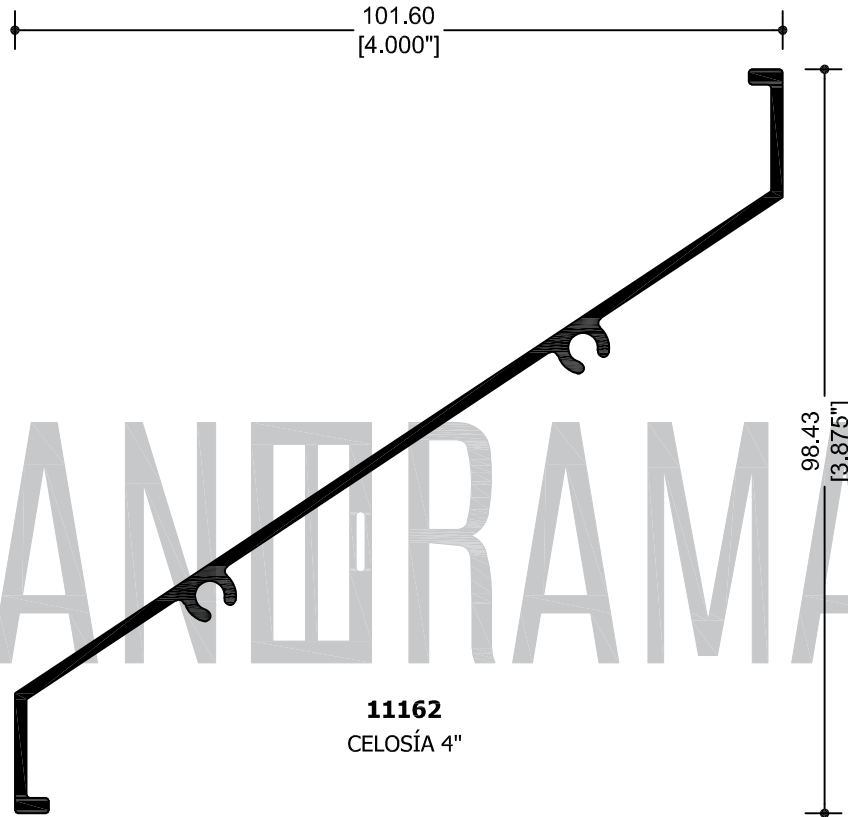

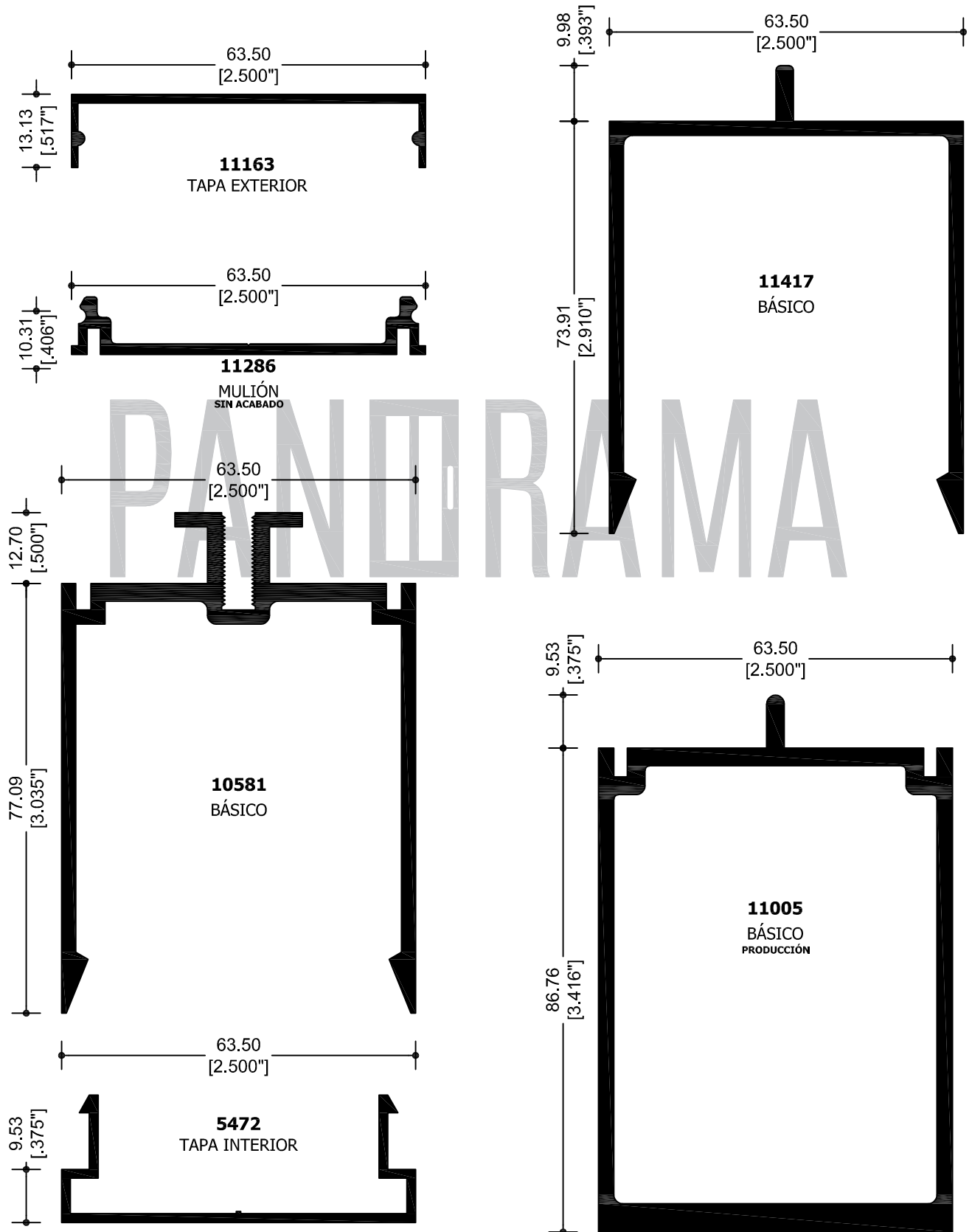

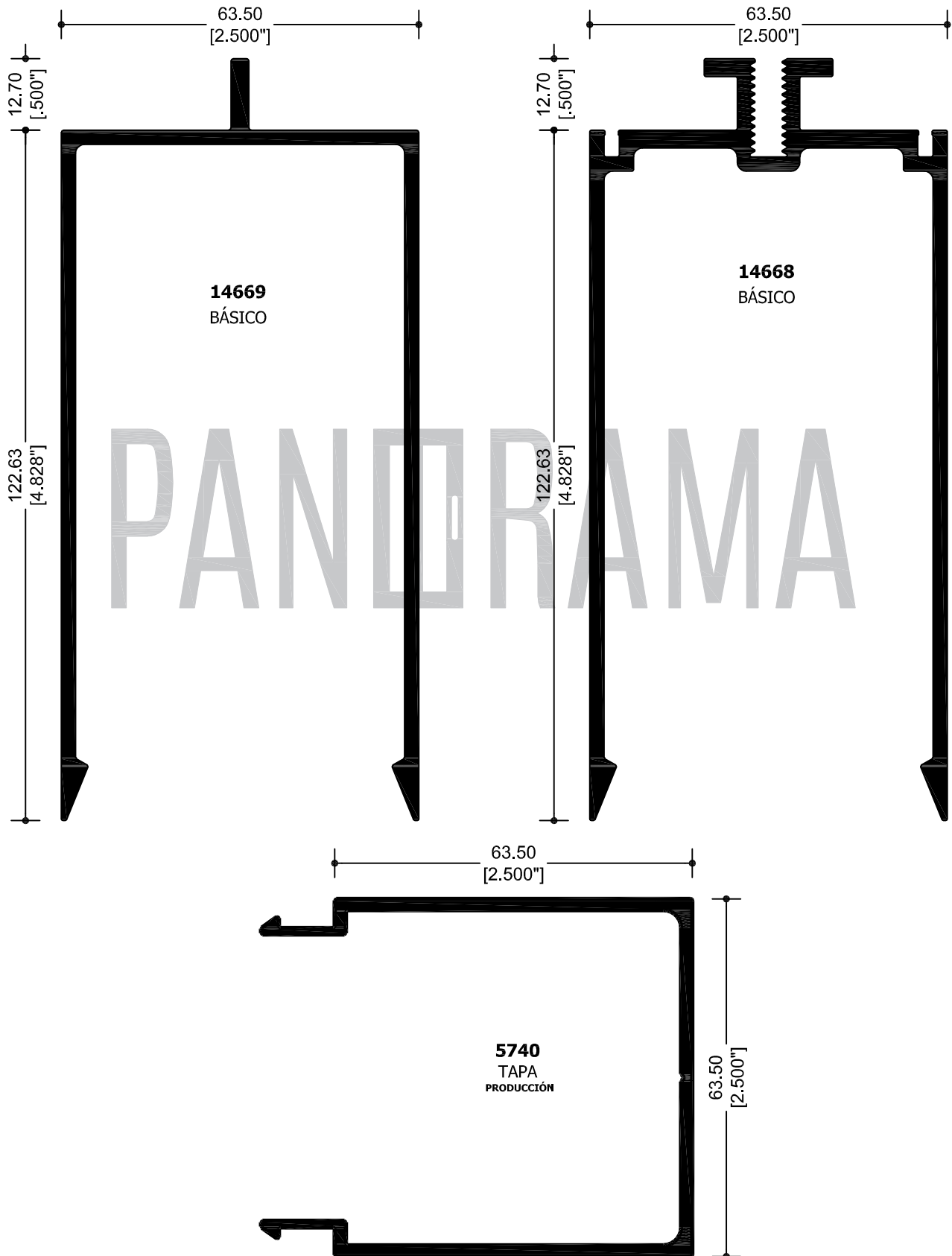

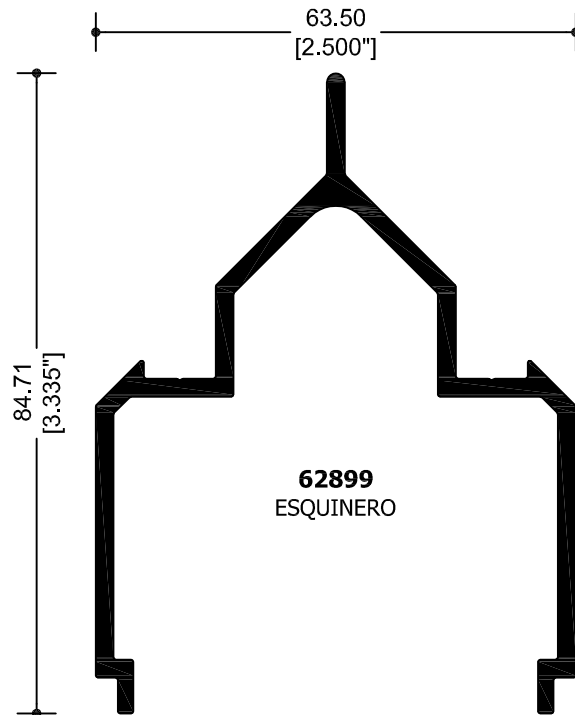
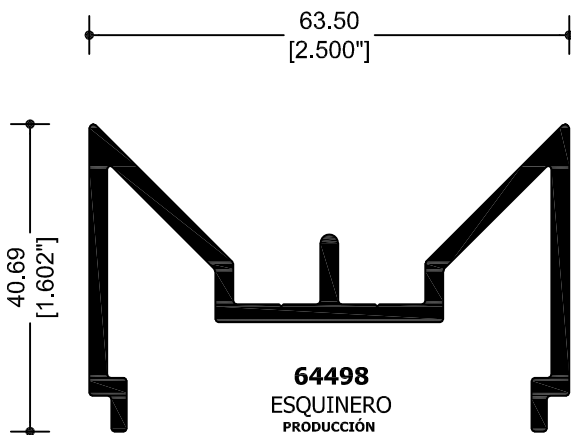
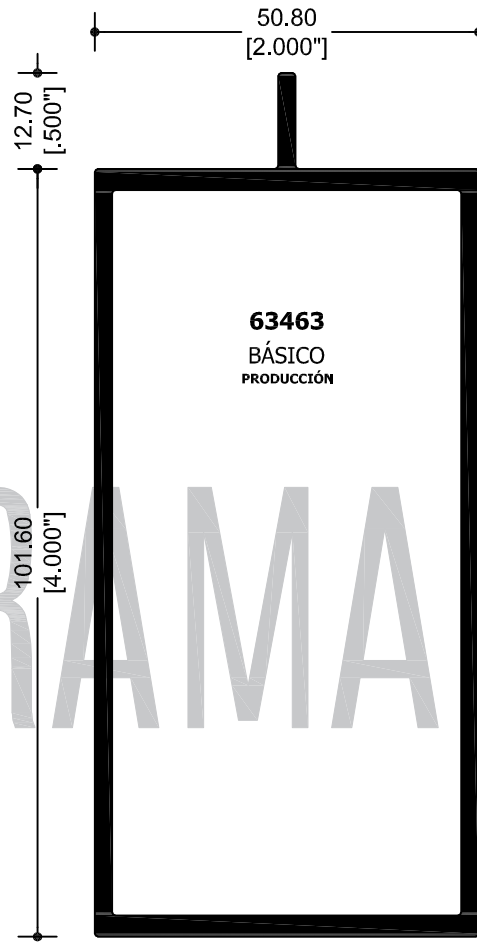
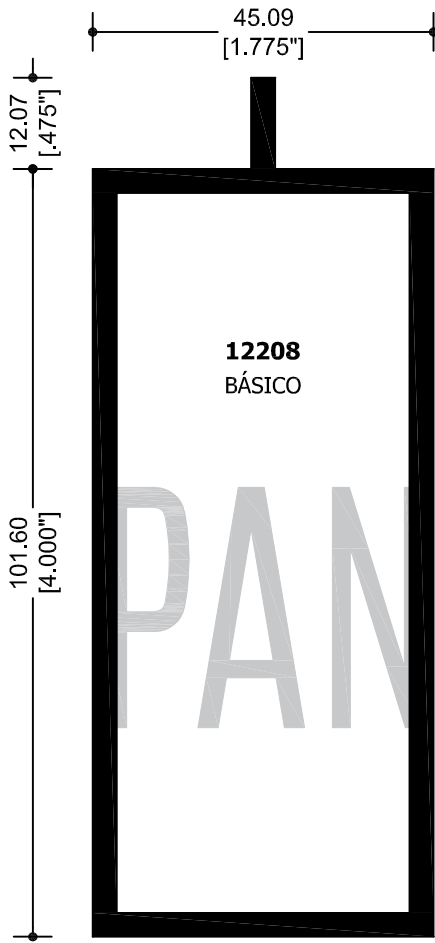

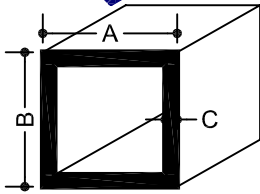

TUBO CUADRADO

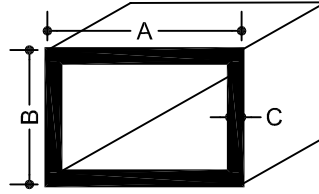

TUBO RECTANGULAR

CLAVE	MEDIDAS EN PULGADAS		
	A	B	C
50170	0.500	0.500	.050
2351	0.750	0.750	.050
22036	0.750	0.750	.062
62488	1.000	1.000	.039
11161	1.000	1.000	.045
2362	1.000	1.000	.050
11154	1.250	1.250	.049
2354	1.250	1.250	.065
62489	1.500	1.500	.044
2363	1.500	1.500	.057
22268	1.500	1.500	.125
11093	1.750	1.750	.050
2364	1.750	1.750	.057
11156	2.000	2.000	.054
2356	2.000	2.000	.065
2369	3.000	3.000	.058
2358	3.000	3.000	.083
2365	4.000	4.000	.125

CLAVE	MEDIDAS EN PULGADAS		
	A	B	C
52500	1.000	0.500	.048
22049	1.000	0.500	.062
62515	1.500	0.750	.045
2515	1.500	0.750	.050
2514	1.500	1.000	.062
62521	2.000	1.000	.044
2521	2.000	1.000	.057
11099	2.500	1.250	.055
65321	3.000	1.000	.048
22242	3.000	1.000	.060
2516	3.000	1.000	.083
62509	3.000	1.500	.044
19613	3.000	1.750	.050
11122	3.000	1.750	.058
2522	3.000	1.750	.078
22273	3.000	2.000	.125
14729	4.000	1.750	.060
2520	4.000	1.750	.078
22107	4.000	1.750	.109
22017	4.000	1.750	.125
2518	4.000	2.000	.109

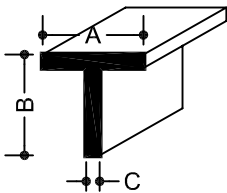

TEES

CLAVE	MEDIDAS EN PULGADAS		
	A	B	C
17256	0.750	0.750	.062
1613	1.000	1.000	.038

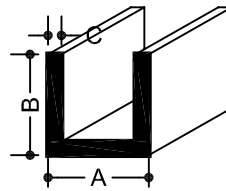

CANALES

CLAVE	MEDIDAS EN PULGADAS		
	A	B	C
1432	0.350	0.350	.035
4688	0.375	0.375	.063
1433	0.500	0.500	.030
18081	0.500	0.500	.063
40156	0.750	0.750	.063
17003	0.750	0.750	.125
1463	1.000	1.000	.063
17977	1.000	1.000	.125

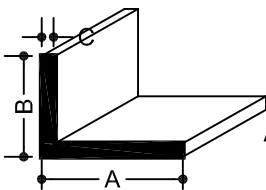

ÁNGULOS LADOS DESIGUALES

CLAVE	MEDIDAS EN PULGADAS		
	A	B	C
16	1.000	0.500	.125
0622	1.500	0.750	.125
1364	1.500	1.000	.125
20	2.000	1.000	.125

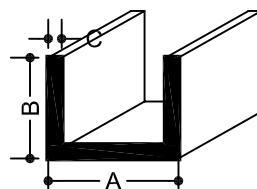

CANALES LADOS DESIGUALES

CLAVE	MEDIDAS EN PULGADAS		
	A	B	C
65498	0.750	0.500	.125
17196	2.000	1.000	.125
4018	2.500	1.500	.125
4017	3.000	1.000	.125
4802	3.000	1.500	.200

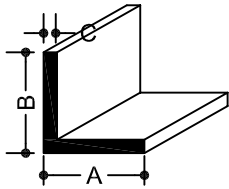

ÁNGULOS

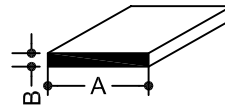

SOLERAS

CLAVE	MEDIDAS EN PULGADAS		
	A	B	C
11031	0.500	0.500	.050
1301	0.500	0.500	.062
9	0.500	0.500	.125
662	0.750	0.750	.040
11033	0.750	0.750	.050
1303	0.750	0.750	.062
11	0.750	0.750	.125
11124	1.000	1.000	.040
1324	1.000	1.000	.050
1304	1.000	1.000	.062
1308	1.000	1.000	.125
25	1.000	1.000	.188
569	1.250	1.250	.063
13	1.250	1.250	.125
26	1.250	1.250	.187
1320	1.500	1.500	.062
14	1.500	1.500	.125
1314	1.500	1.500	.187
372	1.500	1.500	.250
15	2.000	2.000	.125
330	2.000	2.000	.187
1318	2.000	2.000	.250
65496	2.500	2.500	.187
31	2.500	2.500	.250
29	3.000	3.000	.188
47	3.000	3.000	.250
667	4.000	4.000	.250

CLAVE	MEDIDAS EN PULGADAS	
	A	B
18040	0.375	.125
1203	0.500	.125
17578	0.500	.188
17582	0.500	.250
17572	0.625	.125
1201	0.750	.063
18028	0.750	.125
1211	0.750	.188
17584	0.750	.250
1202	1.000	.063
1205	1.000	.125
18091	1.000	.188
17980	1.000	.250
17593	1.000	.375
17574	1.250	.125
17580	1.250	.188
1207	1.500	.125
17083	1.500	.188
17981	1.500	.250
17595	1.500	.375
17597	1.500	.500
17576	2.000	.125
1216	2.000	.188
17708	2.000	.250
17088	2.000	.375
17091	2.000	.500
17086	2.500	.188
17588	2.500	.250
18041	3.000	.125
01218	3.000	.187
17589	3.000	.250
17089	3.000	.375
17092	3.000	.500
17687	4.000	.125
17591	4.000	.250
17628	4.000	.375
1241	4.000	.500
15009	5.000	.125
17592	6.000	.250

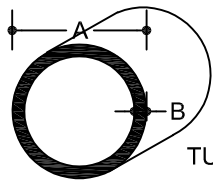

TUBO REDONDO

CLAVE	MEDIDAS EN PULGADAS	
	A	B
65524	0.375	.035
22004	0.375	.050
22023	0.500	.050
22015	0.625	.050
22505	1.000	.040
22356	1.250	.050
22197	1.500	.049
22196	2.000	.065
22326	2.500	.065

TUBO CUADRADO
ESQUINAS REDONDAS

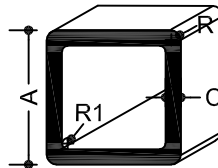

CLAVE	MEDIDAS EN PULGADAS			
	A	C	R	R1
22031	1.000	0.065	.156	.094
22034	1.500	0.065	.190	.125

CLAVE	FIGURA	SUP. ANOD. CM.	SUP. PUL. CM.	LARGO STD. M.	PIEZAS x ATADO	PÁGINA	CLAVE	FIGURA	SUP. ANOD. CM.	SUP. PUL. CM.	LARGO STD. M.	PIEZAS x ATADO	PÁGINA
00011	L	7.62	7.62	3.66	22	43	00667	L	40.64	40.64	3.66	2	43
00013	L	12.70	12.70	3.66	14	43	1201	—	4.13	4.13	3.66	80	43
00014	L	15.24	15.24	6.10	8	43	1202	—	5.40	5.40	3.66	40	43
00015	L	20.22	20.22	3.66	8	43	1203	—	3.17	3.17	3.66	62	43
00016	L	7.62	7.62	3.66	22	42	1205	—	5.71	5.71	3.66	30	43
00020	L	15.24	15.24	3.66	11	42	1207	—	8.19	8.19	3.66	20	43
00025	L	10.16	10.16	3.66	12	43	1211	—	4.76	4.76	3.66	26	43
00029	L	30.48	30.48	3.66	4	43	1216	—	11.11	11.11	6.10	8	36 43
00031	L	25.40	25.40	3.66	4	43	1241	—	22.86	22.86	3.66	2	43
00047	L	30.48	30.48	3.66	3	43	1301	L STOCK MEX	5.08	5.08	6.10	40	43
00330	L	20.32	20.32	6.10	3	43	1303	L STOCK MEX	7.62	7.62	3.66	32	43
00372	L	15.24	15.24	3.66	6	43	1304	L STOCK MEX	10.16	10.16	6.10	24	43
00569	L	12.7	6.35	3.66	25	43	1308	L	10.16	10.16	6.10	10	43
00622	L	11.43	11.43	3.66	16	42	1314	L	15.24	15.24	3.66 6.10	8 4	43
00662	L	7.62	7.62	6.10	40	43	1318	L	20.32	11.43	3.66	5	43

Perfiles de producción, pregunta por el mínimo de compra.

Los estatus de las claves pueden ir cambiando según demanda del mercado.

Vigente 2022.

CLAVE	FIGURA	SUP. ANOD. CM.	SUP. PUL. CM.	LARGO STD. M.	PIEZAS x ATADO	PÁGINA
1320		15.24	15.24	3.66 6.10	16 16	43
1324		10.062	10.062	6.10	32	43
1364		12.7	12.70	6.10	10	42
1432		5.15	5.15	6	72	42
1433		7.47	7.47	6	72	42
1463		14.92	14.92	6.10	16	42
1613		10.16	10.16	6.10	32	42
2351		7.62	7.62	6.10	20	42
2354		12.70	12.70	6.10	9	42
2356		20.32	20.32	6.10	6	42
2358		30.48	30.48	6.10	2	42
2362		10.16	10.16	6.10	16	42
2363		15.24	15.24	6.10	9	42
2364		17.76	17.76	6.10	9	42
2365		40.64	40.64	6.10	1	42

CLAVE	FIGURA	SUP. ANOD. CM.	SUP. PUL. CM.	LARGO STD. M.	PIEZAS x ATADO	PÁGINA
2369		30.48	30.48	6.10	4	42
2514		12.70	12.70	6.10	8	42
2515		11.43	11.43	6.10	12	42
2516		20.32	20.32	6.10	4	42
2520		29.21	29.21	6.10	3	42
2521		15.24	15.24	6.10	8	42
2522		24.13	24.13	6.10	3	42
3316		8.00	5.18	6.10	24	32
4017		24.765	24.765	3.66	8	42
4018		27.305	27.305	3.66	6	42
4042		19.974	9.35	6.10	6	34
4043		26.449	12.12	6.10	6	34
4081		33.4	17.13	6.10	2	34
4105		6	1.62	6.10	40	29
4154		10	7	3.66	16	32













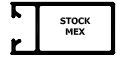

CLAVE	FIGURA	SUP. ANOD. CM.	SUP. PUL. CM.	LARGO STD. M.	PIEZAS x ATADO	PÁGINA
4688		5.40	5.40	3.66	70	42
5115		8	1.65	6.10	24	29
5173		9	4	6.10	20	19
5472		25	8.26	6.10	10	39
5740		44.20	28.95	6.10	4	40
6370		9.40	2.96	6.10	32	29
6371		8.50	2.62	6.10	24	29
7014		6.13	2.14	6.10	36	32
7101		14.6	11.4	6.10	8	19
7102		13.50	6.69	6.10	12	32
7104		21	10.48	6.40	8	21
7105		22	14	6.40	8	21
7106		27	13	6.40	8	21
7107		20	7	6.40	12	21
7108		23.50	10	6.40	8	21





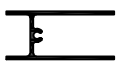





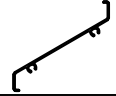

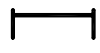

CLAVE	FIGURA	SUP. ANOD. CM.	SUP. PUL. CM.	LARGO STD. M.	PIEZAS x ATADO	PÁGINA
7109		51	7	6.40	4	21
7110		32.83	4.67	6.40	6	21
7112		20.30	14	6.40	8	21
7158		74.77	30.88	6.10	2	12
7333		8.06	3.10	6.10	40	19
7671		28.31	7.991	6.10	8	34
7792		14.50	0	6.10	16	6
7818		7.60	3.80	6.10	20	15
7828		10.50	5.30	6.10	16	18
7949		12.89	5.90	6.10	16	31
7950		15.421	8	5.70	16	31
8184		14.25	4.20	6.10	12	10
8320		18.32	8.08	6.10	8	15
8328		40.80	18.20	6.10	1	35
8524		24.77	10.20	6.10	8	33

























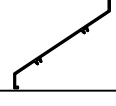

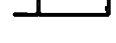

Perfiles de producción, pregunta por el mínimo de compra.

Los estatus de las claves pueden ir cambiando según demanda del mercado.

Vigente 2022.

CLAVE	FIGURA	SUP. ANOD. CM.	SUP. PUL. CM.	LARGO STD. M.	PIEZAS x ATADO	PÁGINA
9078	 PRODUCCIÓN	10.38	0	6.10	28	4
9086		30	8.30	6.10	8	6
9088		11.50	3.5	6.10	32	6
9112		13.23	4.80	6.10	12	7 9 24
9236	 STOCK MEX	23.012	15.474	6.10	8	25
9356		8.01	3.30	6.10	24	4
9525		15.10	8.10	6.10	16	30
9756		13	10.30	6.10	12	30
9947		37	15.20	6.10	8	30
9956		19.10	8.206	6.10	12	14
9959		33.00	15.80	6.10	6	18
9960	 STOCK MTY	28.882	12	6.10	8	18
9963	 STOCK MTY	22.26	15.1	6.10	8	18
9964	 STOCK MTY	23	21	6.10	6	18
9966		10.071	3.57	6.10	20	19

CLAVE	FIGURA	SUP. ANOD. CM.	SUP. PUL. CM.	LARGO STD. M.	PIEZAS x ATADO	PÁGINA
10087		23.80	11.814	6.10	8	37
10088		19	19	6.10	14	37
10103		16	11.8	6.1	12	30
10197		14.88	3.17	5.70	20	30
10198		16.94	3.17	6.10	16	19
10220		7.80	2.37	5.70	30	19
10235		39	12.70	6.10	8	9
10236		35.30	7.90	6.10	6	9
10237		22.70	6	6.10	12	9
10266		21.30	0	6.10	12	8 10
10358		17.50	8.60	6.10	12	19
10465		50.20	15.03	6.10	4	24
10466		28.17	12.88	6.10	8	24
10467		47	11.20	6.10	4	24
10554	 STOCK MEX	7.08	3.45	6.10	32	24

CLAVE	FIGURA	SUP. ANOD. CM.	SUP. PUL. CM.	LARGO STD. M.	PIEZAS x ATADO	PÁGINA	CLAVE	FIGURA	SUP. ANOD. CM.	SUP. PUL. CM.	LARGO STD. M.	PIEZAS x ATADO	PÁGINA
10568	 STOCK MTY	26.03	6.30	6.40	8	20	11096	 STOCK MTY	9.60	3.45	6.10	32	13
10570	 STOCK MTY	25.57	16.71	6.40	8	20	11099		19.05	19.05	6.10	6	42
10571	 STOCK MTY	18.60	6.73	6.40	12	20	11122		24.13	24.13	6.10	3	42
10574	 STOCK MTY	8.03	3	6.40	24	20	11124		10.16	10.16	6.10	32	43
10575	 STOCK MTY	9.67	3.03	6.40	24	20	11154		12.70	12.70	6.10	9	42
10581		55.57	15.39	6.10	2	39	11156		20.32	20.32	6.10	6	42
10697	 PRODUCCIÓN	48.30	20.90	6.10	4	24	11161		10.16	10.16	6.10	16	42
11005	 PRODUCCIÓN	33.10	23.70	6.10	2	39	11162		34.956	34.956	6.10	4	38
11031	 STOCK MEX	5.08	5.08	6.10	40	43	11163		17.62	8.927	6.10	12	39
11032		7.15	1.86	6.10	48	25 29	11173		15.41	11.958	6.10	12	31
11033		7.62	7.62	6.10	32	43	11174		34.90	15.20	6.10	8	31
11035		11.30	3.37	6.10	12	31	11176	 STOCK MEX	29.50	12.50	6.10	8	31
11044		18.27	8.11	6.10	12	14	11203		13.20	5.82	6.10	12	13 15
11046		14.194	10.463	6.10	12	31	11286		17.97	0	6.10	8	39
11093		17.76	17.76	6.10	9	42	11386		14.90	4.01	5.70	24	31































Perfiles de producción, pregunta por el mínimo de compra.

Los estatus de las claves pueden ir cambiando según demanda del mercado.

Vigente 2022.

CLAVE	FIGURA	SUP. ANOD. CM.	SUP. PUL. CM.	LARGO STD. M.	PIEZAS x ATADO	PÁGINA
11387		17.16	4.011	6.10	16	31
11417		45.46	14.78	6.10	2	39
11599		17.20	9.65	6.10	10	37
11670		26.52	10.203	6.10	8	33
11763		5.55	0	6.10	40	13
11835		36.69	7.349	6.10	12	13
11836		14.24	5.08	6.10	16	13
11837		18.659	8.1	6.10	12	13
11838		17.5	3.98	6.10	12	13
12115		37.8	14.70	6.10	2	33
12208		31.75	31.75	6.10	2	41
12428		9.99	8.18	6.10	22	34
12797		36.95	11.90	6.40	6	20
13563		14.80	7.53	6.10	20	30
14286		21.28	7.08	6.10	8	14

CLAVE	FIGURA	SUP. ANOD. CM.	SUP. PUL. CM.	LARGO STD. M.	PIEZAS x ATADO	PÁGINA
14668		73.03	24.52	6.10	2	40
14669		63.58	24.52	6.10	2	40
14729		29.21	29.21	6.10	4	42
15309		28.663	6.46	6.10	12	13
15310		18.471	4.05	6.10	16	13
15311		18.431	7.81	6.10	12	13
15312		13.428	8.88	6.10	16	13
17003		10.69	5.66	3.66	18	42
17083		8.57	8.57	3.66	12	43
17084		9.84	9.84	3.66	9	43
17086		13.65	13.65	3.66	8	43
17088		12.065	12.065	3.66	5	43
17089		17.145	17.145	3.66	4	43
17091		12.70	12.70	3.66	4	43
17092		17.78	17.78	3.66	2	43

CLAVE	FIGURA	SUP. ANOD. CM.	SUP. PUL. CM.	LARGO STD. M.	PIEZAS x ATADO	PÁGINA	CLAVE	FIGURA	SUP. ANOD. CM.	SUP. PUL. CM.	LARGO STD. M.	PIEZAS x ATADO	PÁGINA
17196		19.685	19.685	3.66	8	42	17594		8.255	8.255	3.66	8	43
17231		10.16	10.16	3.66	17	42	17595		9.525	9.525	3.66	8	43
17256		7.62	7.62	3.66	32	42	17597		10.16	10.16	3.66	5	43
17572		3.745	3.745	3.66	50	43	17628		22.225	22.225	3.66	3	43
17574		6.92	6.92	3.66	24	43	17708		11.43	11.43	3.66	8	43
17576		10.73	10.73	3.66	16	43	17977		14.6	7.62	3.66	12	42
17578		3.49	3.49	3.66	42	43	17978		2.79	2.79	3.66	125	43
17580		7.30	7.30	3.66	17	43	17980		6.35	6.35	3.66	14	43
17582		3.81	3.81	3.66	30	43	17981		8.89	8.89	3.66	10	43
17584		5.08	5.08	3.66	22	43	18028		4.38	4.38	3.66	42	43
17588		13.97	13.97	3.66	6	43	18040		2.475	2.475	3.66	82	43
17589		16.51	16.51	3.66	5	43	18041		15.81	15.81	3.66	10	43
17591		21.59	21.59	3.66	4	43	18081		7.30	7.30	3.66	50	42
17592		31.75	31.75	3.66	3	43	18091		6.03	6.03	3.66	12	43
17593		6.985	6.985	3.66	12	43	18270	 <small>STOCK MTY</small>	39.92	11.21	6.10	4	10

Perfiles de producción, pregunta por el mínimo de compra.

Los estatus de las claves pueden ir cambiando según demanda del mercado.

Vigente 2022.

CLAVE	FIGURA	SUP. ANOD. CM.	SUP. PUL. CM.	LARGO STD. M.	PIEZAS X ATADO	PÁGINA
18490		12.06	12.06	3.66	14	42
19095		5.715	5.715	3.66	16	43
19272		20.50	13.38	6.40	16	20
19613		24.13	24.13	6.10	4	43
20569		27.84	6.72	6.40	8	20
20572		9.98	1	6.10	24	20
22004		2.99	2.99	6.10	46	44
22015		4.987	4.987	3.66 6.10	44 26	44
22017		29.21	29.21	6.10	2	47
22023		3.99	3.99	3.66 6.10	55 33	44
22026		24.13	24.13	6.10	3	47
22031		8.43	8.43	6.10	12	44
22034		14.41	14.41	6.10	6	44
22036		7.62	7.62	6.10	16	43
22049		7.62	7.62	6.10	14	42

CLAVE	FIGURA	SUP. ANOD. CM.	SUP. PUL. CM.	LARGO STD. M.	PIEZAS X ATADO	PÁGINA
22107		29.14	29.14	6.10	2	42
22117		9.97	9.97	6.10	10	43
22196		15.96	15.96	3.66 6.10	8 6	43
22197		11.97	11.97	6.10	9	43
22242		20.32	20.32	6.10	6	42
22268		15.24	15.24	6.10	4	42
22273		25.40	25.40	6.10	2	42
22326		19.95	19.95	3.66	6	43
22356		9.97	9.97	6.10	12	43
22505		7.98	7.98	3.66 6.10	24 12	43
24051		11.65	4.74	6.10	16	6
24055		19.806	8.55	6.10	10	11
26606		18.48	6.40	6.10	12	12
26609		30.05	7.44	6.10	8	11
27111		37.86	9.098	6.40	6	21

Perfiles de producción, pregunta por el mínimo de compra.
 Los estatus de las claves pueden ir cambiando según demanda del mercado.
 Vigente 2022.

CLAVE	FIGURA	SUP. ANOD. CM.	SUP. PUL. CM.	LARGO STD. M.	PIEZAS x ATADO	PÁGINA	CLAVE	FIGURA	SUP. ANOD. CM.	SUP. PUL. CM.	LARGO STD. M.	PIEZAS x ATADO	PÁGINA
27316		17.2	7.28	6.10	12	7	29183		19.67	8.60	6.10	6	28
27525		10.813	1.20	6.10	16	15	29207		22.782	10.562	6.10	6	28
27819		43.38	8.75	6.10	6	14	33087		18.79	4.24	6.10	14	25
27862		49.018	7.36	6.10	4	16	35844		25.697	12.91	6.10	8	29
28009		62.56	26.596	6.10	1	35	36370		10.40	2.90	6.10	32	4 29
28183		33.152	6.74	6.10	8	10	37825		27.75	15.76	6.10	8	14
28586		37.303	14.04	6.10	4	6	38370		26.74	3.04	6.10	8	14
28681		17.35	2.13	6.10	12	18	39073		25.95	8.20	6.10	12	4
28936		24.45	6.24	6.10	6	23	39074		22.20	5.32	6.10	12	4
28937		31.249	5.80	6.10	6	23	39075		11.09	2.39	6.10	24	4
28939		15.38	5.10	6.10	12	23	39084		28.91	6.885	6.10	8	6
29076		21.133	9.165	6.10	12	4	39088		10.442	3.517	6.10	32	6
29117		55.753	19.46	6.10	4	11	39115		54.639	21.87	6.10	4	8
29118		48.178	13.159	6.10	4	12	39136		39.041	10.82	6.10	6	7
29119		45.63	20.61	6.10	4	11	39272		33.199	9.416	6.10	6	17

CLAVE	FIGURA	SUP. ANOD. CM.	SUP. PUL. CM.	LARGO STD. M.	PIEZAS x ATADO	PÁGINA	CLAVE	FIGURA	SUP. ANOD. CM.	SUP. PUL. CM.	LARGO STD. M.	PIEZAS x ATADO	PÁGINA
39954		17.897	8.418	6.10	8	15	63299		17.61	17.61	6.10	13	37
40156		11.11	11.11	6.10	20	42	63329		14.846	2.90	6.10	20	32
50170		5.08	5.08	6.10	30	42	63463		32.88	25.35	6.10	2	41
52500		7.62	7.62	6.10	20	42	63727		13.34	3.46	6.10	16	15
53358		15.79	6.75	6.10	12	32	63728		17.96	7.01	6.10	6	15
53883		27.32	22.57	6.10	3	36	64498		35.18	7.23	6.10	4	41
53896		22.219	17.42	6.10	2	36	65321		20.32	20.32	6.10	6	42
59187		33.425	16.183	6.10	4	28	65439		34.93	17.46	3.66	1	42
59204		21.54	16.913	4.60 6.10	6 6	28	65498		8.26	4.45	3.66	24	42
62488		10.16	10.16	6.10	16	42	65524		2.992	2.992	6.10	50	43
62489		15.24	15.24	6.10	9	42	65844		18.535	9.25	6.10	12	28
62509		22.86	22.86	6.10	3	42	66053		24.35	10.81	6.10	8	37
62515		11.43	11.43	6.10	12	42	66533		21.293	9.47	6.10	12	19
62521		15.24	15.24	6.10	8	42	66534		17.001	9.354	4.60	8	19
62899		40.179	7.17	6.10	3	42	66617		31.77	28.76	6.10	6	33

Perfiles de producción, pregunta por el mínimo de compra.

Los estatus de las claves pueden ir cambiando según demanda del mercado.

Vigente 2022.

CLAVE	FIGURA	SUP. ANOD. CM.	SUP. PUL. CM.	LARGO STD. M.	PIEZAS x ATADO	PÁGINA	CLAVE	FIGURA	SUP. ANOD. CM.	SUP. PUL. CM.	LARGO STD. M.	PIEZAS x ATADO	PÁGINA
67013		9.66	2	6.10	36	32	68370		26.74	3.04	6.10	8	14
67166	 PRODUCCIÓN	29.21	22.72	6.10	6	33	67842		34.343	17.17	6.10	4	25 16
67315		25.779	6.17	6.10	8	7	67843		26.181	10.87	6.10	8	17
67362		31.61	31.61	6.10	3	38	67844		24.798	11.31	6.10	8	17
67518		37.168	8.07	6.10	8	14	67847		22.031	14.774	4.60	8	17
67819		49.52	8.64	6.10	6	14	68550	 STOCK MEX	20.58	9.55	6.10	12	25
67821		14.10	10.76	4.60	12	15	68591		26.861	11.381	6.10	8	6
67822		22.22	15.92	6.10	8	15	69082		27.448	9.86	6.10	8	18 26
67826		43.24	23.11	6.10	6	16	69083		32.69	0	6.10	8	6
67835		35.059	13.20	6.10	8	25 16	69085		15.7	3.62	6.10	16	6
67836		24.386	8.619	6.10	8	25 16	69105		41.458	12.1	6.10	4	7
67848		29.311	16.182	4.60	8	17	69114		37.57	16.72	6.10	4	7
67850		27.25	13.93	6.10	6	17	69135		46.023	15.365	6.10	4	7
67862		56.03	6.87	6.10	4	17	69272		32.562	11.12	6.10	6	16
68327		39.90	18.28	6.10	1	35	69366		31.696	12.322	6.10	6	36

CLAVE	FIGURA	SUP. ANOD. CM.	SUP. PUL. CM.	LARGO STD. M.	PIEZAS x ATADO	PÁGINA	CLAVE	FIGURA	SUP. ANOD. CM.	SUP. PUL. CM.	LARGO STD. M.	PIEZAS x ATADO	PÁGINA
69768		23.721	8.512	6.10	12	16	69891		11.923	3.425	6.10	30	5 22 27
69776		58.709	25.68	6.10	1	35	69955		21.557	10.985	4.60	12	15
69877		20.297	6.725	6.10	8	5	69957		27.682	16.461	6.10	8	16
69878		24.96	8.454	6.10	7	22	70164		23.609	11.518	6.10	6	26
69881		24.96	8.454	6.10	6	22	70165		29.477	14.356	6.10	2	26
69885		38.51	24.98	6.10	2	26	70166		29.477	14.432	6.10	2	26
69887		11.389	2.154	6.10	30	5 22 27	70647		38.24	22.611	6.10	2	27
69888		12.005	2.481	6.10	30	5 22 27	77862		49.65	9.80	6.10	6	16
69889		5.347	2.537	6.10	30	22	72534		20.26	7.46	6.10	2	22
69890		12.768	3.752	6.10	30	5 22 27	81581		32.485	13.08	6.10	6	33

Perfiles de producción, pregunta por el mínimo de compra.
 Los estatus de las claves pueden ir cambiando según demanda del mercado.
 Vigente 2022.

Agradeceremos sus comentarios sobre este catálogo.
 Atención: Departamento de asesoría técnica Grupo Cuprum.
 Contacto: vozdelcliente@cuprum.com

Recuerda que Cuprum te ofrece líneas diferenciadas para que puedas distinguirte de tus competidores, consúltalas en

www.ventanaseurovent.com

EUROVENT 
C L A S S I C

EUROVENT 
P R E M I U M

Certifica tu taller, pregunta a tu distribuidor para mas información.

Este manual y sus diseños están protegidos bajo varias patentes.
Los diseños de los perfiles son propiedad de Cuprum.
Prohibida su reproducción total o parcial.



PANORAMA

Código CUPRUM:
CPSP-2022



cuprum.com/construccion



Planta Nuevo León

Diego Díaz de Berlanga No. 132,
Col. El Nogalar, San Nicolas
de los Garza, N. L., C.P. 66480



Planta Jalisco

Antigua Carretera a Chapala
No. 3345, Alamo Industrial,
Guadalajara, Jalisco



Planta México

Av. La Presa No. 290, Col. San
Juan Ixhuatepec, Tlalnepantla,
Edo. de México, C.P. 54180